

# ACCESSORIES & RACER TAPE

## OUTERWEARS STEERING WHEEL COVERS



PART NO.	DESCRIPTION	RACER NET
AP2085BK	Black	\$8.50
AP2085BL	Blue	8.50
AP2085R	Red	8.50

## OUTERWEARS TIRE COVERS

Fits up to 7.1 x 6

PART NO.	DESCRIPTION	RACER NET
	(Set of 4)	
AP2084BK	Black	\$23.93
AP2084BL	Blue	23.93
AP2084R	Red	23.93



## NON-SKID TAPES

Great for floor pans, gas and brake pedals, trailer ramps, around work benches, machines and many more.

PART NO.	DESCRIPTION	RACER NET
AP4761	2" x 10' Roll	\$9.00
AP4762	3" x 10' Roll	13.13
AP4763	4" x 10' Roll	17.25



## STANDARD DUTY RACERS TAPE

2" X 90' Roll

RACER NET - \$5.95

PART NO.	COLOR
AP1127	Red
AP1128	Blue
AP1129	Yellow
AP1130	Black
AP1132	White
AP1134	Orange
AP1818	Purple

### New Colors

AP5086	Chrome
AP5087	Neon Yellow
AP5088	Neon Green
AP5089	Neon Orange
AP5090	Neon Pink

## EXTREME DUTY RACERS TAPE

Highly aggressive & heavy. Succeeds where other tapes fail. 2" X 90' Roll

RACER NET \$7.95

PART NO.	COLOR
AP5091	Red
AP5092	Black
AP5093	Silver
AP5094	White

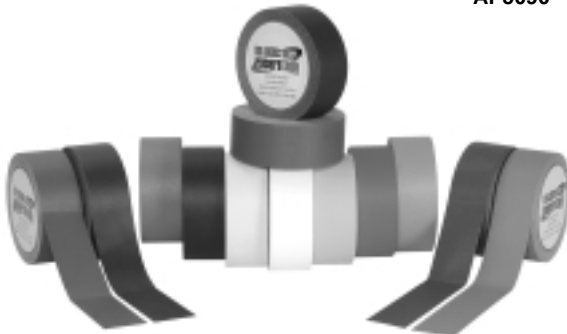

## DULL FINISH RACERS TAPE

Provides a waterproof and dirt resistant seal. Conforms to odd shaped surfaces

Permits easy & clean removal

2" x 90' Roll

RACER NET \$10.95

PART NO.	COLOR
AP5095	Red
AP5096	Blue
AP5097	Black
AP5098	White
AP5099	Neon Yellow
AP5100	Neon Green
AP5101	Neon Pink
AP5102	Neon Orange

NOTE: Neon Colors 2" x 45'



## SURFACE GUARD TAPE

Clear protective tape. Helps protect surfaces prone to scratching or chipping such as body panels  
8 mil thickness

PART NO.	DESCRIPTION	RACER NET
AP5103	2" x 30' Roll	\$32.60
AP5104	3" x 30' Roll	49.30
AP5105	4" x 30' Roll	60.00
AP5225	2" x 12' Roll	21.95
AP5226	4" x 12' Roll	29.95



## CHECKER BOARD TAPE

PART NO.	DESCRIPTION	RACER NET
AP1819	2" x 45' Roll	\$7.50
AP4764	3" x 45' Roll	9.95

## ANGLED CHECKER BOARD TAPE



PART NO.	DESCRIPTION	RACER NET
AP4970	2" x 45' Roll	\$7.15

# ACCESSORIES

ORDERS ONLY  
1-800-262-0555  
ALL QUESTIONS  
440-564-8100

## FLEXIBLE IMPACT RESISTANT NUMBER PLATES

PART NO.	DESCRIP.	RACER NET
AP975	White	\$1.50
AP976	Black	1.50
AP977	Yellow	1.50
AP978	Red	1.50
AP979	Blue	1.50

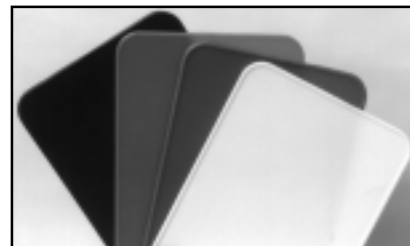

## 6" SELF STICK NUMBERS

Red, White or Black, easy to read at a distance for accurate scoring.



PART NO.	DESC.	RCR. NET	PART NO.	DESC.	RCR NET	PART NO.	DESC.	RCR NET
W40151	White #1	\$.35	W47661	Black #1	\$.35	AP9691	Red #1	\$.35
W40152	White #2	.35	W47662	Black #2	.35	AP9692	Red #2	.35
W40153	White #3	.35	W47663	Black #3	.35	AP9693	Red #3	.35
W40154	White #4	.35	W47664	Black #4	.35	AP9694	Red #4	.35
W40155	White #5	.35	W47665	Black #5	.35	AP9695	Red #5	.35
W40156	White #6	.35	W47666	Black #6	.35	AP9696	Red #6	.35
W40157	White #7	.35	W47667	Black #7	.35	AP9697	Red #7	.35
W40158	White #8	.35	W47668	Black #8	.35	AP9698	Red #8	.35
W40159	White #9	.35	W47669	Black #9	.35	AP9699	Red #9	.35
W40150	White #0	.35	W47660	Black #0	.35	AP9690	Red #0	.35
W4015S	White Set (0-9)	3.25	W4766S	Black Set (0-9)	3.25	AP969S	Red Set (0-9)	3.25

## STICK-ON NUMBER PANEL

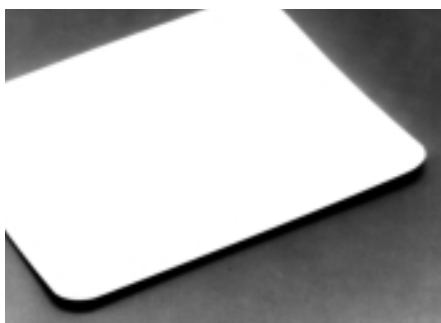

PART NO.	DESCRIPTION	RACER NET
AP2223	White 9" x 7 1/4"	\$0.85
AP5229	Yellow 9" x 7 1/4"	0.85

## FLEXIBLE PLASTIC MOUNTING CLAMPS

Great for mounting number plates or side pods

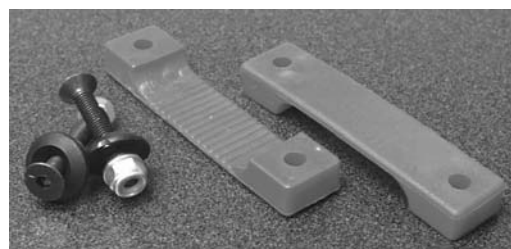

PART NO.	DESCRIPTION	RACER NET
AP3090	1 Pair Red Mounting clamps w/hdwr	\$2.95
AP3090	1 Pair Black Mounting clamps w/hdwr	2.95

## SLANTED NUMBERS

Adhesive backed (peel-off) 6" *SLANTED* Numbers. Available in digits from 0-9.



PART NO.	DESCRIPTION	RACER NET
AP13091	Black #1	\$.35
AP13092	Black #2	.35
AP13093	Black #3	.35
AP13094	Black #4	.35
AP13095	Black #5	.35
AP13096	Black #6	.35
AP13097	Black #7	.35
AP13098	Black #8	.35
AP13099	Black #9	.35
AP13090	Black #0	.35
AP1309S	Black Set (1 ea. 0-9)	3.25
AP13101	White #1	.35
AP13102	White #2	.35
AP13103	White #3	.35
AP13104	White #4	.35
AP13105	White #5	.35
AP13106	White #6	.35
AP13107	White #7	.35
AP13108	White #8	.35
AP13109	White #9	.35
AP13100	White #0	.35
AP1310S	White Set (1 ea. 0-9)	3.25

# STOP WATCHES

## SC-501 MULTI-MODE STOPWATCH



Provides 2 distinct options: Interval (LAP), or Accumulated (SPLIT) timing.

- Lap or split timing
- Can be used for single events
- 1/1000 second resolution to 24 hours
- Auto-release to running time
- Single action time readings
- Time-out (pause) timing
- Audible beep confirmation

PART NO.	RACER NET
AP2524	\$24.95

## SC-505 FIVE MEMORY CHRONO



Ultra-precise, multi-mode stopwatch with memory recall and lap counter.

- Lap, split or event timing
- 1/1000 second precision to 24 hours
- 5 memory recall
- Auto-lap counter to 99
- Auto lap/split release
- Single action time readings
- 1st - 5th place times
- Time-out (pause) timing

PART NO.	RACER NET
AP2525	\$26.95

## SC-554 30 MEMORY SPEED TIMER



Perfect blend of speed and chronograph functions for racing and all sports.

- Speed timer displays lap speed in MPH/KPH
- 30 lap memory of speed, lap time and number
- Automatic lap counter to 999
- Distance entry precise to 1/1000 mi/km
- Fastest & average lap times, on demand
- Twin chronographs - lap or split timing modes
- 1/1000 second precision to 24 hours

PART NO.	RACER NET
AP2527	\$40.45

## SC-848 200 DUAL MEMORY CHRONO SPEED COUNTDOWN • BACKLIGHT

Analyzes performance in more ways, with more precision than any other product.

- EL backlight illuminates entire display
- 300 dual split memory recall
- 1/100 second precision to 25 hours
- User selectable running lap or split time
- Automatic lap counter to 999
- Fastest, slowest & average lap times
- Speed timer in MPH/KPH
- 300 memory recall of lap speed, time and number
- Distance input precise to 1/1000 mi/km
- Dual countdown timers

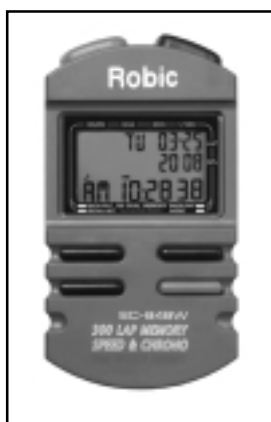

PART NO.	RACER NET
AP2528	\$56.95

## TIMERS WITH BOARDS



PART NO.	DESCRIPTION	RACER NET
AP2529	Single head board with pad & SC544	\$74.95
AP2530	Dual head board with pad & two SC544	115.40
AP2532	Dual head board w/pad & two SC808 Closeout	109.95
AP2933	Replacement pad	3.95

# GAUGES MOUNTS & STEERING WHEELS

ORDERS ONLY  
1-800-262-0555  
ALL QUESTIONS  
440-564-8100



**MYCHRON 4 STEERING WHEELS**

PART NO.	GRIP COLOR	SPOKE COLOR	RACER NET
AP5036	Black/Black	Silver	\$142.95
AP5037	Black/Red	Silver	142.95
AP5038	Black/Orange	Silver	142.95
AP5039	Black/Silver	Purple	142.95

**MYCHRON STEERING WHEEL MOUNT**

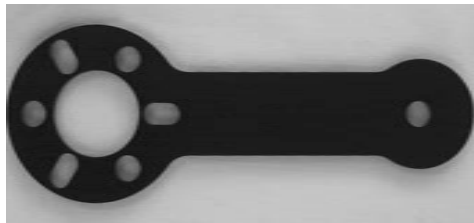

PART NO.	DESCRIPTION	RACER NET
G1843	MYCHRON STEERING WHEEL MOUNT	\$9.23



**MYCHRON "TACH" BRACKET**

PART NO.	RACER NET
AP5016	\$9.95

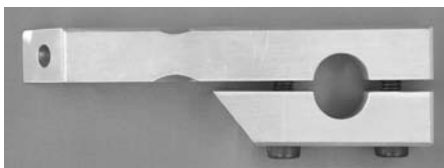

**MYCHRON CHAMP KART MOUNT**

PART NO.	DESCRIPTION	RACER NET
G1844	MYCHRON CHAMP KART MOUNT FOR 3/4" TUBING	\$12.89

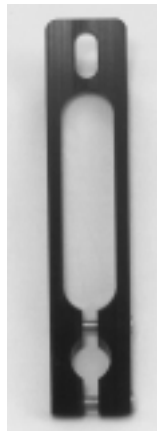

**STEERING MYCHRON SHAFT MOUNT**

AP4666

PART NO.	DESCRIPTION	RACER NET
AP4666	MYCHRON GAUGE MOUNT WORKS WITH ALL TYPES OF STEERING SHAFTS	\$17.95

**MYCHRON GPS MODULE**



We often think that GPS modules are useful for map-tracking purposes only, but GPS can be used to acquire much more important data: from brakes with speed, position (including drivers errors) and visualize this information in Google Earth.

PART NO.	RACER NET
AP5157	\$337.16

**MYCHRON 4 2-TEMP GAUGES**



TACH/EGT/WATER

TACH/CHT/EGT

PART NO.	DESCRIPTION	RACER NET
MY4B2TCE	TACH/CHT/EGT (GREEN DISPLAY)	\$463.91
MY4B2TCEA	TACH/CHT/EGT (AMBER DISPLAY)	463.91
MY4B2TEW	TACH/EGT/WATER (GREEN DISPLAY)	463.91
MY4B2TEWA	TACH/EGT/WATER (AMBER DISPLAY)	463.91

# MYCHRON GAUGES

ORDERS ONLY  
1-800-262-0555  
ALL QUESTIONS  
440-564-8100

## MYCHRON 4



The introduction of the new MyChron4 brings with itself a new way of showing the most important information acquired in test sessions, races and analysis sitting: RPM, Temperatures and Laptime. We've stepped up our technology with a pixel-based graphical display that easily shows large, easy to read numbers (like exhaust temps), sharp, detailed histograms and graphs (like torque curves), even graphics (like team logos). Get more from your MyChron4 without the need to connect to a laptop, as you view power curves and RPM histograms right on the display. Replay your entire racing session as soon as you get off the track.

There's more to the MyChron4 than just a pretty face.

Check out these advanced features:

- Two configurable Alarm Leds
- Configurable shift led
- Intuitive menu design for easy configuration
- Automatic start
- Long battery life (up to 200 hours with an internal 9V battery)
- 1 MB memory

PART NO.	DESCRIPTION	RACER NET
MY4B	Green Display	\$362.51
MY4BA	Amber Display	362.51

## MYCHRON 4 "Gold" E-Box

The optional MyChron4 E-Box enables you to collect even more data, satisfying even advanced data acquisition junkies. The E-Box has four inputs, providing:- Speed- 2 Temperatures- RPM An internal accelerometer (G-sensor) allows you to create a track map on your PC, giving you a complete look at kart and driver performance. Pick a spot on the track and immediately see speed, temps, RPM and more. See which line gave the fastest lap time.



PART NO.	DESCRIPTION	RACER NET
AP5009	"Gold" E-Box	\$463.91

## MYCHRON 4 Memory Key & Software



Download your data into the optional Data-Key, a compact interface that collects data from the MyChron 4 and transfers them to the PC through the USB connection, ready to be analyzed by our powerful Race Studio 2 software.

PART NO.	DESCRIPTION	RACER NET
AP4917	Memory Key & Software	\$97.50

Part No.	Description	Racer Net
AP4374	EGT Sensor (2 piece)	\$78.00
AP4390	EGT Thermocouple	43.88
AP4376	14mm CHT Sensor (2 piece)	78.00
AP4389	14mm CHT Sensor (1 Piece)	43.88
AP4393	14mm CHT Thermocouple	43.88
AP5158	10mm CHT Sensor (1 Piece)	43.88
AP5159	10mm CHT Sensor (2 Piece)	78.00
AP5167	10mm CHT Thermocouple	43.88
AP4394	Patch Cable 1 Temp (TC)	34.13
AP5162	Patch Cable 2 Temp (TC/TC)	48.75
AP5163	Patch Cable 2 Temp (TC/TR)	48.75
AP4392	10mm Water Thermocouple	43.88
AP4750	10mm Water Temp Sensor (2 PC TR Style)	87.75
AP47505	5mm Water Temp Sensor (2 PC TR Style)	87.75
AP5160	Inline Water Coupler 3/4" for 10mm Sensor	43.88
AP4383	RPM Sensor	10.73
AP5168	RPM Clip	1.46
AP4384	Speed (MPH) Sensor	73.13
AP4395	Magnet for Speed Sensor	7.80
AP4385	Axle Collar 1.250"	10.73
AP4386	Axle Collar 40mm	10.73
AP4387	Axle Collar 45mm	10.73
AP4388	Axle Collar 50mm	10.73
AP4382	Magnetic Receiver	57.53
AP4585	Beacon Receiver (Infrared)	57.53
AP4938	Beacon	48.75

## REPLACEMENT SENSORS & ACCESSORIES FOR MYCHRON 3 & 4 GAUGES



Outerwears  
Covers for  
Mychron 3 & 4  
Gauges

Part No.	Color	Racer Net
AP4752BK	Black	\$12.34
AP4752BL	Blue	12.34
AP4752R	Red	12.34

# DIGATRON REPLACEMENT SENSORS & ACCESSORIES

ORDERS ONLY  
1-800-262-0555  
ALL QUESTIONS  
440-564-8100

## FOR NEW STYLE DT30, DT40 & DT50 GAUGES

**Note:** These sensors & accessories are for instruments with **NO SHORT PIGTAIL WIRES** on the back of the instrument. All connectors are small metal twist & lock (**BC**) and mount directly to the back of the instrument.

\* Indicates **STANDARD** replacement parts.

CHT=Cylinder Head Temperature EGT=Exhaust Gas Temperature TACH=Revolutions per Minute MPH= Miles per Hour

PART NO.	DESCRIPTION	RACER NET	PART NO.	DESCRIPTION	RACER NET
AP4431	CHT SENSOR (3')	\$44.10	AP4450	MPH KIT	\$67.50
*AP4432	CHT SENSOR (5')	44.10	(SENSOR, EXTENSION, COLLAR & BRACKET)		
AP4433	CHT EXTENSION (4')	20.70	AP4453	AXLE COLLAR (ADJUSTABLE 1" to 1.5")	13.50
AP4436	SOUTHLAND EGT SENSOR (3')	63.38	AP4454	BEACON RECEIVER	54.00
AP4437	SOUTHLAND EGT SENSOR (5')	63.38	AP4455	BEACON TRANSMITTER	89.10
AP4439	EGT CLAMP ASSEMBLY	13.00	AP4456	PC DOWNLOAD CABLE (6') SERIAL PORT	58.50
AP4440	EGT WELD ON FITTING	11.00	AP4457	PC DOWNLOAD CABLE (15') SERIAL PORT	67.50
AP4441	TACH SENSOR INDUCTIVE (3')	26.10	AP4458	MANUAL TIMING SWITCH (5')	22.50
*AP4442	TACH SENSOR INDUCTIVE (5')	26.10	AP4052	NOISE SUPPRESSOR SPARK PLUG BOOT	3.95
AP4443	TACH EXTENSION (4')	20.70	AP4459	TEMPERATURE SHORTING PLUG	10.00
AP4444	JACKSHAFT RPM KIT	67.50	AP4460	STANDARD MOUNT, FLAT	14.63
(SENSOR, EXTENSION, COLLAR & BRACKET)			(SPOKE UP OR DOWN)		
AP4445	MPH/JACKSHAFT SENSOR	44.10	AP4461	JR DRAGSTER MOUNT, FLAT (TILTED UP)	19.50
AP4446	MPH/JACKSHAFT EXTENSION	20.70	AP4571	PC DOWN LOAD CABLE KIT	58.50
AP4447	JACKSHAFT COLLAR (3/4" BORE ONLY)	22.50			
AP4449	TACH SENSOR (MSD-NO TACH OUTPUT) 5'	26.10			

## FOR OLDER STYLE DT40 & DT50 GAUGES

**Note:** These sensors & accessories are for instruments **WITH SHORT PIGTAIL WIRES** on the back of the instrument. All connectors are small metal push on (**RF**), small metal twist-on (**RF**) or larger twist & lock (**BNC**)

\* Indicates **STANDARD** replacement parts.

CHT=Cylinder Head Temperature EGT=Exhaust Gas Temperature TACH=Revolutions per Minute MPH= Miles per Hour

PART NO.	DESCRIPTION	RACER NET	PART NO.	DESCRIPTION	RACER NET
*AP4462	CHT SENSOR <b>RF</b> CONNECTOR (5')	\$44.10	AP4472	MPH KIT <b>BNC</b> CONNECTOR (5')	\$67.50
AP4463	CHT EXTENSION <b>RF</b> CONNECTOR (4')	20.70	AP4453	AXLE COLLAR (ADJUSTABLE 1" to 1.5")	13.50
AP4464	CHT SENSOR <b>BNC</b> CONNECTOR (5')	44.10	AP4454	BEACON RECEIVER	54.00
AP4466	EGT EXTENSION <b>BNC</b> CONNECTOR (4')	20.70	AP4455	BEACON TRANSMITTER	89.10
AP4439	EGT CLAMP ASSEMBLY	13.00	AP4457	PC DOWNLOAD CABLE <b>BNC</b> CONN (15')	67.50
AP4440	EGT WELD-ON FITTING	11.00	SERIAL PORT		
*AP4467	TACH SENSOR <b>RF</b> CONNECTOR (5')	26.10	AP4474	MANUAL TIMING SWITCH <b>BNC</b>	22.50
AP4468	TACH EXTENSION <b>RF</b> CONNECTOR (4')	20.70	CONNECTOR (5')		
AP4469	JACKSHAFT RPM KIT <b>BNC</b> CONNECTOR	67.50	AP4475	WATER TEMP SENSOR <b>RF</b> CONNECTOR (5')	36.00
(SENSOR, EXTENSION, COLLAR & BRACKET)			AP4476	CHT/WT SHORTING PLUG <b>RF</b> CONNECTOR	10.00
AP4052	NOISE SUPPRESSOR SPARK PLUG BOOT	3.95	AP4477	EGT SHORTING PLUG <b>BNC</b> CONNECTOR	10.00
AP4445	MPH/JACKSHAFT SENSOR	44.10	AP4478	STEERING WHEEL MOUNT, "U" SHAPED	14.63
AP4471	MPH/JACKSHAFT EXTENSION	20.70	AP4461	JR DRAGSTER MOUNT, FLAT (TILTED UP)	19.50
<b>BNC</b> CONNECTOR (5')			AP4571	PC DOWN LOAD CABLE KIT (6') SERIAL PORT	58.50
AP4447	JACKSHAFT COLLAR (3/4" BORE ONLY)	22.50			

## FOR ORIGINAL DT30 & "E" GAUGES

**Note:** These sensors & accessories are for instruments **WITH SHORT PIGTAIL WIRES** on the back of the instrument. All connectors are small metal push on (**RF**), small metal twist-on (**RF**) or plastic push on Molex (**MX**)

\* Indicates **STANDARD** replacement parts.

CHT=Cylinder Head Temperature EGT=Exhaust Gas Temperature TACH=Revolutions per Minute MPH= Miles per Hour

PART NO.	DESCRIPTION	RACER NET	PART NO.	DESCRIPTION	RACER NET
*AP4462	CHT SENSOR <b>RF</b> CONNECTOR (5')	\$44.10	AP4483	MPH/JACKSHAFT SENSOR	\$44.10
AP4463	CHT EXTENSION <b>RF</b> CONNECTOR (4')	20.70	<b>MX</b> CONNECTOR (1')		
AP4479	CHT SENSOR <b>MX</b> CONNECTOR (5')	44.10	AP4471	MPH/JACKSHAFT EXTENSION	20.70
*AP4480	EGT SENSOR <b>MX</b> CONNECTOR (5')	63.38	<b>MX</b> CONNECTOR (5')		
AP4481	EGT EXTENSION <b>MX</b> CONNECTOR (4')	20.70	AP4447	AXLE COLLAR (3/4" BORE ONLY)	22.50
AP4439	EGT CLAMP ASSEMBLY	13.00	AP4486	MANUAL STORE SWITCH	22.50
AP4440	EGT WELD-ON FITTING	11.00	<b>MX</b> CONNECTOR (5')		
*AP4467	TACH SENSOR <b>RF</b> CONNECTOR (5')	26.10	AP4475	WATER TEMP SENSOR <b>RF</b> CONNECTOR (5')	36.00
AP4468	TACH EXTENSION <b>RF</b> CONNECTOR (4')	20.70	AP4052	NOISE SUPPRESSOR SPARK PLUG BOOT	3.95
AP4482	MPH KIT <b>MX</b> CONNECTOR	67.50	AP4476	CHT/WT SHORTING PLUG <b>RF</b> CONNECTOR	10.00
(SENSOR, EXTENSION, COLLAR & BRACKET)			AP4487	EGT SHORTING PLUG <b>MX</b> CONNECTOR	10.00
			AP4488	STEERING WHEEL MOUNT	14.63
			(BALL MOUNT STYLE)		
			MB100A	STEERING WHEEL MOUNT "E" SERIES	8.50

# DIGATRON



DT46



DT32



DT31

PART NO.	RACER NET	FUNCTIONS	DISPLAYS	WEIGHT (OZ)	LENGTH (IN)	HEIGHT (IN)	DEPTH (IN)	DATALOGGING (# OF MINUTES)	PC DOWNLOADING	LAP TIMING	BACKLIGHT	# OF LED WARNING LIGHTS	PROGRAMMABLE WINDOWS	MAX RECALL
DT46KTEK	\$229.50	TACH/CHT/EGT	1	10	2.8	3.5	1.2	35	NO	**	Y	NA	NO	Y
DT46K	169.15	TACH/CHT	1	10	2.8	3.5	1.2	35	NO	**	Y	NA	NO	Y
DT32K3LT	262.65	EGT-CHT/TACH	2	12	3.5	3	1.2	NA	NO	**	Y	3	Y	Y
DT32K1LT	212.50	TACH-CHT	2	12	3.5	3	1.2	NA	NO	**	Y	3	Y	Y
DT31K3LT	262.65	TACH/CHT/EGT	1	14	4	3.5	1.2	NA	NO	**	Y	3	Y	Y
DT31K1LT	212.50	TACH/CHT	1	14	4	3.5	1.2	NA	NO	**	Y	3	Y	Y
DT31KLT	195.50	TACH	1	14	4	3.5	1.2	NA	NO	**	Y	3	Y	Y

\*\* Requires purchase of a beacon receiver and use of a trackside beacon transmitter (either Digatron or a competitors)  
 CHT=Cylinder Head Temperature EGT=Exhaust Gas Temperature TACH=Revolutions per Minute MPH= Miles per Hour  
**ALL GAUGES ARE SOLD WITH MOUNT AND SENSORS (BATTERIES ARE NOT INCLUDED)**

## DIGATRON SENSOR END CONNECTION TYPES



BC TYPE



BNC TYPE



MOLEX TYPE



RF TYPE

# JR. Dragster, 305 & Lawn Mower Access.

ORDERS ONLY  
1-800-262-0555  
ALL QUESTIONS  
440-564-8100



## FRONT WHEELS & HUBS

PART NO.	DESCRIPTION	MAP PRICE
D75002	10"x 2" DSM solid w/cap	\$99.90
D75003	10"x 2" DSM 5 Star w/cap	122.85
D70527	5"x 3.25" wheel	26.25
W2922	Hub 5/8" brg. 1/4" studs	16.95

## REAR WHEELS & HUBS

PART NO.	DESCRIPTION	Inside	Outside	MAP PRICE
D00501	8"x 8" (4 on 4")	3"	5"	\$41.85
D00524	10"x 8" (4 on 4")	3"	5"	54.90
D00537	10"x 8" (4 on 4")	4"	4"	77.85
D00519	10"x 10" (4 on 4")	4"	6"	60.30
D02113	8"x 8" (5 on 130mm)	3"	5"	45.45
D02102	8"x 9" (5 on 130mm)	4"	5"	41.85
D02105	10"x 8" (5 on 130mm)	3"	5"	54.90
AP4961	1 1/4" hub (4 on 4")			48.32
AP4960	1" hub (4 on 4")			48.32

\*\* Prices shown here are the Manufacturer's Minimum Advertised Price (MAP). To get your discounted racer net pricing call 440-564-8100 or visit [www.apsorderline.com](http://www.apsorderline.com)

## ROBERTSON 305 INTEK HEADERS



AP5258



AP5261

PART NO.	DESCRIPTION	RACER NET
AP5258	13" Long Two Stage Header (Requires Silencer)	\$43.70
AP5259	13" Long Two Stage Header (Flared end)	49.70
AP5260	23" Long 3-Stage Supersnake Header Kit (Requires Silencer)	59.70
AP5261	29" Long 4-Stage Supersnake Header Kit (Flared end)	64.70

## 305 INTEK DUAL VALVE SPRING KIT



PART NO.	RACER NET
GP305DVSK	\$44.95

## 305 INTEK HIGH PERFORMANCE PUSH ROD



PART NO.	DESCRIPTION	RACER NET
GP4673	305 Intek pushrod 6.73" Long x .250" OD (Sold each)	\$10.75

## U-WELD LAWNMOWER HEADER PIPE KIT



PART NO.	DESCRIPTION	RACER NET
AP5262	Fits 8 to 10HP Briggs You cut and fit to your chassis and weld the slip over joints.	\$39.70
AP5262A	Fits 12HP Briggs	39.70
AP5262B	Fits 18HP Briggs	39.70
AP5262C	Fits 23HP V-Twin Briggs	74.45

# LAWN MOWER & MINI CUP

ORDERS ONLY  
1-800-262-0555  
ALL QUESTIONS  
440-564-8100

## ROBERTSON TORQUE TUBE HONDA GX-390 (13 hp)



PART NO.	DESCRIPTION	RACER NET
AP4790	Honda GX-390 Header (req. silencer)	\$44.10
RLV 4120	MMRA Silencer	33.27
RLV B91XL	Standard Silencer	37.61
RLV B91MO	Modified Silencer	41.03
AP5248	GX-390 Supersnake Header (req. silencer)	60.10
AP5249	GX-390 Supersnake Header (washer end)	65.10
AP5250	GX-390 Supersnake Header (flared end)	65.10

## MINI CUP CALIPER (1" Bore) Black Only!

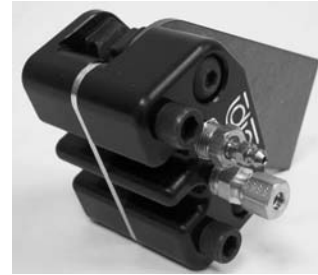

PART NO.	DESCRIPTION	RACER NET
MCP650M	Relieved Anvil Caliper Assembly w/pads (DOT 5 fluid only)	\$108.38
MCP651	Relieved Anvil Caliper Half (body only)	47.25

**\*\* For replacement parts see the MCP brake section**

## #40/41 SPLIT STYLE SPROCKETS

6 bolts on a 5 1/4" bolt circle  
with a 4 9/16" bore.  
Premium High Strength  
Aluminum.



## MINI WINSTON HUBS



PART NO.	DESCRIPTION	RACER NET
AP4958	Front Hub w / 3/4" Bearings 4 on 4 Bolt Circle	\$57.60
AP4959	1 1/4" rear Hub w / 4 on 4 Bolt Circle	54.40

## 1 PIECE MINI WINSTON & RACING LAWN MOWER WHEELS



- Made from .190 thick material designed for heavy side loads.
- 4 on 4" Bolt Circle 2 1/2" BORE
- (Does not come with valve stem)

PART NO.	WIDTH	INSIDE	OUTSIDE	DIA.	RACER NET
D80050	6"	3"	3"	8"	\$44.63
D80051	8"	3"	5"	8"	46.13
W2925	VALVE STEM				.97

PART NO.	TEETH	DIA.	RACER NET
AZ531440S	40	6.52"	\$22.69
AZ531441S	41	6.68"	27.94
AZ531442S	42	6.85"	27.94
AZ531443S	43	7.00"	27.94
AZ531444S	44	7.17"	27.94
AZ531445S	45	7.33"	27.94
AZ531446S	46	7.50"	27.94
AZ531447S	47	7.66"	27.94
AZ531448S	48	7.82"	27.94
AZ531449S	49	7.99"	34.31
AZ531450S	50	8.15"	34.31
AZ531451S	51	8.31"	34.31
AZ531452S	52	8.48"	34.31
AZ531453S	53	8.64"	34.31
AZ531454S	54	8.80"	34.31
AZ531455S	55	8.96"	34.31
AZ531456S	56	9.13"	34.31
AZ531457S	57	9.29"	34.31
AZ531458S	58	9.45"	34.31
AZ531459S	59	9.62"	41.63
AZ531460S	60	9.78"	41.63
AZ531461S	61	9.94"	41.63
AZ531462S	62	10.11"	41.63
AZ531463S	63	10.27"	41.63
AZ531464S	64	10.43"	41.63
AZ531465S	65	10.60"	41.63
AZ531466S	66	10.76"	41.63
AZ531467S	67	10.92"	41.63
AZ531468S	68	11.08"	44.44
AZ531469S	69	11.25"	44.44
AZ531470S	70	11.41"	44.44

## #40 ROLLER CHAIN for RACING LAWN MOWERS & QUARTER MIDGETS



PART NO.	DESCRIPTION	RACER NET
AP5073	10' Roll	\$16.13
AP5075	Master Link	.49
AP5076	Offset Link	.64

# LAWN MOWER & MINI CUP

ORDERS ONLY  
1-800-262-0555  
ALL QUESTIONS  
440-564-8100

## Vertical Crankshaft Billet I Beam Rods (no dippers)



AP4769



AP4770



AP4771



AP4772



AP4778

AP4780



AP4792



## Briggs Model 19

Part #	Description	Racer Net
AP4769	5.00" rod uses .490" wrist pin .530 comp. height piston (req. AP4770)	\$139.25
AP4770	Brass crank weights (syncro substitute)	79.95
AP4771	"Dogbone" billet syncro counterweight link (fits Briggs Models 19 and 28)	25.00

## Briggs Model 28

Part #	Description	Racer Net
AP4772	5.125" stock length rod (req. AP4773)	\$139.95
AP4773	Brass crank weights (syncro substitute)	79.95

## Briggs V-Twin Intek

Part #	Description	Racer Net
AP4774	4.50" stock length rod (sold each 2 required)	\$129.95

## Briggs V-Twin Vanguard 14,16,18 & 20 HP

Part #	Description	Racer Net
AP4775	4.134" stock length rod (sold each 2 required)	\$129.95
AP4776	4.262" stock length rod +.128" (sold each 2 required)	129.95

Note: These rods also fit the horizontal crankshaft Vanguards

## Tecumseh Formula 8 & 10 HP

Part #	Description	Racer Net
AP4777	3.95" stock length rod for 5/8" wrist pin	\$139.95
AP4778	3.95" stock length rod for .688" wrist pin	139.95
AP4779	4.45" length rod for 5/8" wrist pin	139.95

## Rod Bearings

Part #	Description	Racer Net
AP4780	Briggs model 19	\$20.25
AP4781	Briggs model 28	20.25
AP4782	Briggs V-Twin Intek	20.25
AP4783	Briggs V-Twin Vanguard	22.50
AP4784	Tecumseh Formula 8 & 10 HP	20.25

## Rod Bolts

Part #	Description	Racer Net
AP4785	Rod bolt set 5/16-24 for Briggs Model 28	\$6.37
AP4786	Rod bolt set for Briggs Model 19, V-Twin Vanguard & Intek	14.82

## HONDA GX-340/390

PART NO.	DESCRIPTION	RACER NET
AP4792	Billet Rod w/bearings 4.41" Stock length w/scoop	\$149.95
AP4793	Rod Bearings (1-pair)	25.50
AP4794	Rod Bolts (1-pair)	6.38

# QUARTER MIDGET ACCESSORIES

**Mychron Tach  
Mounting Brackets**



PART NO.	DESC.	RACER NET
AP5061	Bracket 5/8" bore	\$27.80
AP5062	Bracket 3/4" bore	27.80
AP5063	Bracket 7/8" bore	27.80

**Tapered Engine  
Mounting Plate**



PART NO.	DESC.	RACER NET
AP5067	(Studs included)	\$90.06

**Honda Throttle  
Linkage Kit**



PART NO.	DESC.	RACER NET
AP5064	Honda Linkage	\$55.86
AP5065	Honda Cable	5.67

**Sendec Tach  
Mounting Brackets**

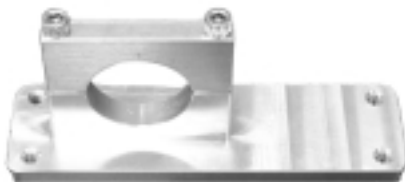

PART NO.	DESC.	RACER NET
AP5059	Bracket 3/4" bore	\$27.80
AP5060	Bracket 7/8" bore	27.80

**Flat Engine  
Mounting Plate**



PART NO.	DESC.	RACER NET
AP5068	1/4" Thick plate	\$43.07
AP5069	1/2" Thick plate	61.95

**Steering Wheel  
Quick Disconnect fits 5/8"  
Shafts**



PART NO.	DESC.	RACER NET
AP5070	Complete Kit	\$58.80
AP5071	Spline Only	21.89

**Honda Air Filter  
Adapter**



PART NO.	RACER NET
AP5072	\$23.63

**Engine Starter  
Pull Strap**



PART NO.	RACER NET
AP5066	\$17.00

**#40 Roller Chain**



PART NO.	DESC.	RACER NET
AP5073	10' Roll	\$16.13
AP5075	Master Link	.49
AP5076	Offset Link	.64

**Axle Sprockets 23T – 34T (#40 chain)**

Light weight 2-piece aluminum sprockets are CNC machined for accuracy and heat treated for durability.

\*\* Please add number of teeth to part no. when ordering.

PART NO.	RACER NET
AP5074**	\$18.02



# LUBRICANTS

ORDERS ONLY  
1-800-262-0555  
ALL QUESTIONS  
440-564-8100



## TRI-FLOW 2 OZ. SUPERIOR LUBRICANT

PART NO.	DESCRIPTION	RACER NET
AP5144	2 oz Squeeze Bottle	\$2.95
AP5144C	Case of 12 2 oz Squeeze Bottles	27.36



## TRI-FLOW 6 OZ. SUPERIOR LUBRICANT

PART NO.	DESCRIPTION	RACER NET
AP5145	6 oz Aerosol Can	\$5.99
AP5145C	Case of 12 6 oz Aerosol Cans	68.04



## TRI-FLOW 12 OZ. SUPERIOR LUBRICANT

PART NO.	DESCRIPTION	RACER NET
AP5146	12 oz Aerosol Can	\$9.50
AP5146C	Case of 6 12 oz Aerosol Cans	53.55



## POWER PLUS 4-CYCLE OIL

- 100% synthetic • Quicker acceleration & higher RPMs.
- Consistent lap times due to lubricant stability.
- For use in engines running methanol, gasoline or nitromethane.

PART NO.	DESCRIPTION	RACER NET
AP1245	1 qt. Power Plus 4-cycle oil	\$11.25
AP1245C	1 case of Power Plus 4-cycle oil	125.10



## LIQUID HORSEPOWER OIL ADDITIVE

Add to 4-cycle engine oil for .2 to .5 quicker lap times. Enhances a more complete combustion. Not IKF or WKA sniffer legal. Passes most flame tests. One bottle treats 2 crank-case fills.

PART NO.	DESCRIPTION	RACER NET
AP2550	Hot oil additive	\$8.95

## POWER PLUS CASTOR/SYNTHETIC 2-CYCLE OIL

- Quicker lap times. • For gasoline and alcohol use.

PART NO.	DESCRIPTION	RACER NET
AP1246	1 pt. Power Plus 2-cycle oil	\$7.99
AP1246C	1 case of Power Plus 2-cycle oil	89.10

## POWER PLUS 100% SYNTHETIC 2-CYCLE OIL

- For gasoline use only

PART NO.	DESCRIPTION	RACER NET
AP1513	1 pt. Power Plus 2-cycle oil (gas only)	\$7.99
AP1513C	1 case Power Plus 2-cycle oil (gas only)	89.10

## OILS ALL CHAIN LUBE



Formulated using the latest technology, OILS ALL Chain Lube can extend the life of your chain and sprocket by as much as 300%. Excellent for both dirt and asphalt karts.

PART NO.	DESCRIPTION	RACER NET
AP2551	Chain lube 8 oz.	\$3.95

# LUBRICANTS



## R-50 RACING SYNTHETIC

Recommended for use in 2-cycle engines. Protective film strength equal to castor bean oil. Maintains clean burning characteristic of synthetic lubricant. **Will Not Mix with Alcohol.**

PART NO.	DESCRIPTION	RACER NET
KL104C	Case of 10 Quarts	\$100.47
KL104	1 Quart Bottle	10.72

PART NO.	DESCRIPTION	RACER NET
<b>Benol Racing castor oil</b>		
BC175C	Case of 10 pints	\$58.17
BC175	1 Pint bottle	6.24
<b>2-Cycle Techniplat racing lubricant Mixes w/alcohol and nitro</b>		
KL200C	Case of 10 quarts	\$90.12
KL200	1 Quart bottle	9.64
<b>2-Cycle Super Techniplat racing lubricant Mixes w/alcohol and nitro</b>		
KL100C	Case of 10 quarts	\$90.15
KL100	1 Quart bottle	9.64
<b>Foam filter oil aerosol can 15.5oz.</b>		
KL606C	Case of 10 cans	\$55.05
KL606	1 Can	5.88
<b>Fabric filter oil aerosol can 15.5oz. For K&amp;N type filters</b>		
KL607C	Case of 10 cans	\$55.05
KL607	1 Can	5.88
<b>Fabric &amp; Foam Filter Cleaner</b>		
KL608C	Case of 10 Cans	\$55.05
KL608	1 Can 16oz.	5.88



## KLOTZ KLR CLEAN CHAIN LUBE

Klotz KLR chain lube sprays on smoothly, dries quickly, dries clear and will not fling off. Specially formulated for conventional and o-ring type roller chains.

Part No.	Description	Racer Net
KL611	15.5 oz. aerosol can	\$7.16
KL611C	Case of 10	66.94



## BURRIS 2-CYCLE BOTTLED HORSEPOWER

No other engine is tortured like a Kart engine. Stuck rings, scored cylinders and bearing seizures from a day at 14,000 RPM are normal. Hi-Rev oil tackles those problems-and boosts your engine's horsepower at the same time.

Hi-Rev Castor is made from rich castor oils, yet our oil burns incredibly clean.

PART NO.	DESCRIPTION	RACER NET
BMC901	16 oz Hi-Rev Oil	\$5.95
BMC901C	16 oz Hi-Rev Oil (Case of 12)	69.23
BMC902	16 oz Hi-Rev Castor	7.42
BMC902C	16 oz Hi-Rev Castor (Case of 12)	86.25

## BLENDZALL RACING OILS



PART NO.	DESCRIPTION	RACER NET
AP468	Green label racing castor, 1 Pt.	\$5.95
AP468C	Green label racing castor, case of 12	61.79
AP4408	Racing castor, (Green) 1 Qt. Bottle	10.95
AP4408C	Racing castor, (Green) case of 12	113.78
AP4555	FK100 2-Cycle Oil 1 Qt. Bottle	11.70
AP4555C	FK100 2-Cycle Oil of 12 Quarts	120.62
AP1511	Ultra 2 cycle racing castor, 1pt	5.15
AP1511C	Ultra 2-cycle racing castor, case of 12	53.19
AP1512	Racing chain, lube, 14oz spray can	6.95
AP1512C	Racing chain, lube, case of 12	72.24

# LUBRICANTS

ORDERS ONLY  
1-800-262-0555  
ALL QUESTIONS  
440-564-8100



## 2 & 4 CYCLE RACING OILS

PART NO.	DESCRIPTION	RECOMMENDED APPL.	RACER NET
AP2135	62R, 1 QT	2 or 4 Cycle	\$9.20
AP2135C	62R, Case of 12	2 or 4 Cycle	103.50
AP2560	FHS Hurricane Lite Oil, 1 Qt.	Stock	9.28
AP2560C	FHS Hurricane Lite Oil, Case of 12 Qts.	Stock	104.40
AP2561	FHS Hurricane Medium Oil, 1 Qt.	Modified	9.28
AP2561C	FHS Hurricane Medium Oil, Case of 12 Qts.	Modified	104.40

# RED-E BRIGGS/VALVOLINE THOR OIL RACING OIL



PART NO.	DESC	RACER NET
AP5153	1 Gallon	\$36.00

PART NO.	DESC	RACER NET
100104	1 Gallon	\$28.95

PART NO.	DESCRIPTION	RACER NET
AP5253	Lite (1 Gal)	\$22.95
AP5254	Medium (1 Gal)	22.95
AP5255	Heavy (1 Gal)	22.95
AP5256	Break In (1 Gal)	22.95

## COOL POWER RACING OILS

AN ONGOING COMMITMENT TO EXCELLENCE  
Blue & Green -Total Synthetic , Gold-Castor synthetic blend.



**Light** for use in stock classes (*not to be mixed with "hot additive"*).  
**Medium** for use in stock and mod. classes.  
**Heavy** for use in mod. classes.

PART NO.	DESCRIPTION	RACER NET
AP1514	4-cycle Green Lite 1 qt	\$9.36
AP1514C	4-cycle Green Lite Case of 12 qts.	89.95
AP1515	4-cycle Green Lite 1 Gal.	23.95
AP1516	4-cycle Green Medium 1 qt.	9.36
AP1516C	4-cycle Green Medium Case of 12 qts.	89.95
AP1517	4-cycle Green Medium 1 gal.	23.95
AP1518	4-cycle Green Heavy 1 qt.	9.36
AP1518C	4-cycle Green Heavy case of 12 qts.	89.95
AP1519	4-cycle Green Heavy 1 Gal.	23.95
AP1520	4-cycle Gold Lite 1 qt.	9.36
AP1520C	4-cycle Gold Lite case of 12 qts.	89.95
AP1521	4-cycle Gold Lite 1 gal.	23.95
AP1522	4-cycle Gold Medium 1 qts.	9.36
AP1522C	4-cycle Gold Medium case of 12 qts.	89.95
AP1523	4-cycle Gold Medium 1 gal.	23.95
AP1524	4-cycle Gold Heavy 1 qt.	9.36
AP1524C	4-cycle Gold Heavy case of 12 qts.	89.95
AP1525	4-cycle Gold Heavy 1 gal.	23.95
AP1526	2-cycle Blue 1 qt.	10.53
AP1526C	2-cycle Blue case of 12 qts.	104.95
AP1527	2-cycle Blue 1 gal.	26.95
AP1529	2-cycle Gold 1 gal.	26.95

# TORQUE CONVERTORS & PULLEY CLUTCHES

## MAX TORQUE DRIVEN UNITS



PART NO.	DESC.	RACER NET
AP5445	MAX TORQUE DRIVE UNIT 3/4" BORE	\$57.23



PART NO.	DESC.	RACER NET
AP5446	OUTBOARD MOUNT 7" DIA. 3/4" BORE	\$61.05
AP5559	OUTBOARD MOUNT 7" DIA. 5/8" BORE	65.97



PART NO.	DESC.	RACER NET
AP5447	INBOARD MOUNT 7" DIA. 3/4" BORE	\$61.05
AP5560	INBOARD MOUNT 7" DIA. 5/8" BORE	65.97

## MAX TORQUE BELTS

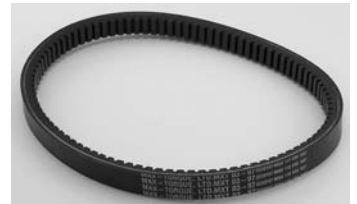

PART NO.	DESC.	RACER NET
AP5448	29.108" OC MXT 03-97	\$21.20
AP5449	29.655" OC MXT 04-98L	21.68

## COMET BELTS

PART NO.	DESC.	RACER NET
203578A	27.36" OC 20/340 SERIES	\$24.95
203580A	29.28" OC 20/340 SERIES	24.95
203581A	30.25" OC 20/340 SERIES	24.95
203582A	31.25" OC 20/340 SERIES	24.95
203583A	32.20" OC 20/340 SERIES	24.95
203585A	33.78" OC 20/340 SERIES	24.95
203586A	35.14" OC 20/340 SERIES	24.95
203589A	27.36" OC 30 SERIES	21.95
203590A	28.32" OC 30 SERIES	21.95
203591A	29.28" OC 30 SERIES	21.95
203593A	31.23" OC 30 SERIES	21.95
203597A	35.14" OC 30 SERIES	21.95
203785A	33.87" OC 40 SERIES	29.95



PART NO.	DESC.	RACER NET
200344A	DRIVER WEIGHT ASSY Fits Max-Torque, Comet 20 & 30 Driver units	\$32.78



PART NO.	DESC.	RACER NET
28030002	DRIVEN SPRING INBOARD	\$7.42
28030003	DRIVEN SPRING OUTBOARD	\$7.42



PART NO.	DESC.	RACER NET
28030002	DRIVEN SPRING INBOARD	\$7.42



PART NO.	DESC.	RACER NET
204097A	DRY LUBE 11 oz spray can	\$14.95



PART NO.	DESC.	RACER NET
AP5527	3/4" Bore Pulley Clutch use on Briggs or Tecumseh engines replacement for Carter Bros. Karts	\$71.88

PART NO.	DESC.	RACER NET
AP5528	3/4" Bore Pulley Clutch use on Clone or Honda engines replacement for Carter Bros. Karts	71.88



PART NO.	DESC.	RACER NET
P32034	3/4" Bore Pulley Clutch	\$41.95



PART NO.	DESC.	RACER NET
2825100301	WEAR PADS SET OF 3 Fits Inboard & Outboard Units	\$11.81

# MINI-BIKE KIT & ACCESSORIES

ORDERS ONLY  
1-800-262-0555  
ALL QUESTIONS  
440-564-8100

## ORIGINAL CONCEPT MINI BIKE

- Economical
- Rugged construction
- No welding needed
- Unpainted

Jig welded from high quality 7/8 OD by .083 wall tubing, it is designed to accommodate up to and including 17.5 OD mounted wheels. Complete with engine mounting plate, front axle holes and rear mounting tabs. No additional welding is required. Most components needed to complete the mini bike are available from American Power Sports. Total weight with forks...19 pounds

Also available in kit form with all the component parts, except the engine and clutch, needed to assemble a mini-bike. Kit includes tires, wheels, sprocket, chain, brake, control components, seat and misc. hardware. Frame, and kit both ship UPS.

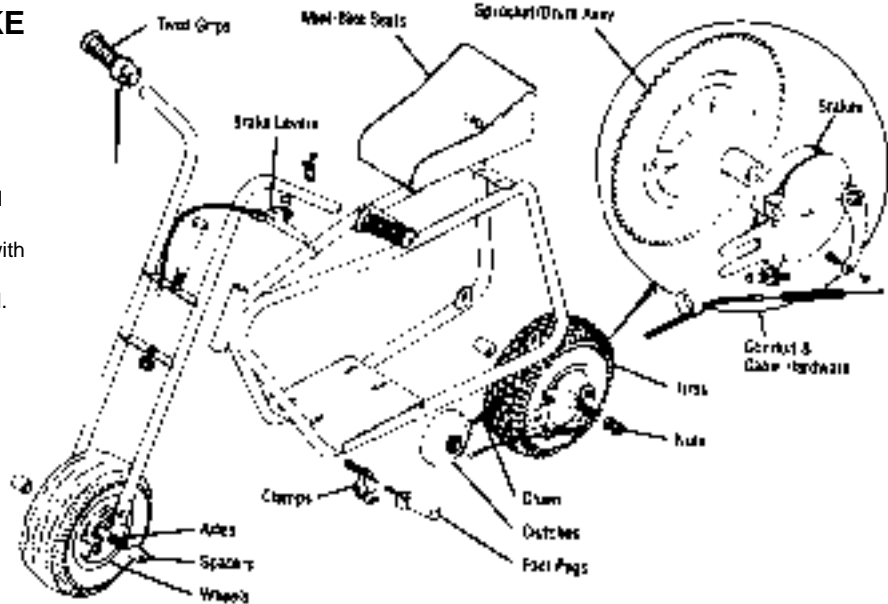

PART NO.	DESCRIPTION	RACER NET	PART NO.	DESCRIPTION	RACER NET
AZ3540**	Mini-Bike Kit w/5" Wheels & Tires	\$269.95	*** COMPONENT KITS SOLD LESS FRAME, FORK, ENGINE & CLUTCH		
AZ3541**	Mini-Bike Kit w/6" Wheels & Tires	299.95	AZ3545	Mini-Bike Frame & Fork Only	\$90.38
AZ3542**	Mini-Bike Kit w/8" Wheels & Tires	339.95	AZ3546i	Mini-Bike Fork Only (30° Angle)	36.25
AZ3544**	Mini-Bike Kit w/10" Wheels & Tires	359.95			
** KITS SOLD LESS ENGINE & CLUTCH					
AZ3540LF***	Mini-Bike Components Only Kit w/5" Tires & Wheels	199.95			
AZ3541LF***	Mini-Bike Components Only Kit w/6" Tires & Wheels	242.92			
AZ3542LF***	Mini-Bike Components Only Kit w/8" Tires & Wheels	277.50			
AZ3544LF***	Mini-Bike Components Only Kit w/10" Tires & Wheels	287.25			

## JACKSHAFT KITS COMPONENTS - 3/4" JACKSHAFT

PART NO.	DESCRIPTION	RACER NET
AZ8201	Bearings 3/4" I.D. x 1 3/8" O.D.	\$1.28
AZ8560	Collar 3/4"	1.24
AZ8454	Key 3/16" x 3/16" x 3/4"	.25
AZ8128	Bearing Hanger - weld on	1.80
AZ8183	Jackshaft 14" x 3/4" w / 3/16" Keyway	8.21



## COMPONENTS - 5/8" JACKSHAFT

PART NO.	DESCRIPTION	RACER NET
AZ8128	Bearing Hanger - Weld on	\$1.80
AZ8175	Jackshaft - 10" x 5/8" w/ 3/16" kwy	4.88
AZ8176	Jackshaft - 12" x 5/8" w/ 3/16" kwy	5.21
AZ8205	Precision Bearings - Double sealed	2.95
AZ8454	Key - 3/16" x 3/16" x 3/4"	.25
AZ8555	Collar	1.01

PART NO.	DESCRIPTION	RACER NET
AZ1826	Jackshaft Kit - 5/8" x 10" (#35 chain) has 13 & 18 tooth sprockets	\$24.19
AZ1827	Jackshaft Kit - 5/8" x 12" (#35 chain) has 13 & 18 tooth sprockets	24.71
AZ1824	Jackshaft Kit - 3/4" x 14" (#40 chain) has 9 & 12 tooth sprockets	28.46

## AMERICAN-MADE THROTTLE ASSEMBLY KITS...

with matching "sweetcorn" super soft grips. The Standard Throttle Assembly combined with a 54" flexible cable covered by a spiral-steel, vinyl-covered housing, lined with a special slippery plastic...Assembled, ready to go. They feature chrome plated mounting cases and self-lubricating bearing surfaces for long, trouble-free service.

PART NO.	DESCRIPTION	RACER NET
AZ2350	Throttle Set, 7/8" I.D.	\$10.46
AZ2352	Throttle/Cable Assy. for 7/8" Handlebars	22.46



# MINI-BIKE ACCESSORIES



## PROFESSIONAL BRAKE LEVER

Rugged lever handle is stamped and shaped mild-steel. Unlike cast handles these will bend rather than fracture. The split mounting-collar is strong yet narrow to allow its positioning closer to curves and bends of handlebars.

PART NO.	DESCRIPTION	RACER NET
AZ1729	Professional Brake Lever - 7/8"	\$12.38
W1063	60" Brake Cable	3.35

## MACHINED AXLES... For Two-Wheelers!

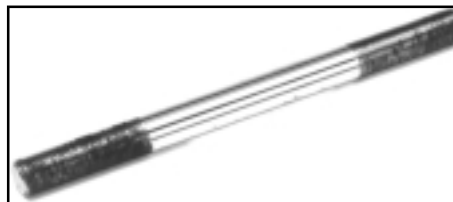

O.D.	THREAD	LENGTH	PART NO.	RACER NET
5/8"	18 x	8"	AZ8124	\$5.21
5/8"	18 x	10"	AZ8120	5.96
Locknuts	5/8" - 18		AZ8515	.25



## BUSHINGS AND SPACERS

DESCRIPTION	ID	OD	LENGTH	PART NO.	RACER NET
Bushings	5/8"	1"	7/8"	AZ8324	\$ 1.65
Bushings	5/8"	1"	1-1/4"	AZ8321	1.88
Bushings	5/8"	1"	1-3/8"	AZ8367	1.95
Bushings	5/8"	1"	1-5/8"	AZ8323	2.14
Bushings	5/8"	1"	2-1/2"	AZ8369	3.00
Bushings	5/8"	1"	5"	AZ8358	4.69
Bushings	3/4"	1"	1/2"	AZ8325	1.24
Bushings	3/4"	1"	1-5/8"	AZ8320	2.14
3/4"-16	3/4"	1 1/2"	1/2"	AZ8319	1.69
Threaded Bushing					



## KILL BUTTON SWITCH

This spring loaded, ground contact switch fits both 7/8" and 1" frame or handle bars. A 36" shielded lead wire, with spade type end fitting is factory assembled to save time and trouble. Plated to look great, this switch is a real safety feature for all vehicles.

PART NO.	DESCRIPTION	RACER NET
AZ1721	Kill Switch -each, packaged	\$3.38

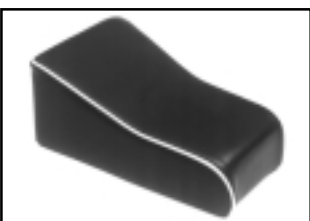

## MINI BIKE SEATS

- Threaded inserts for positive mount
- High quality cover
- Sturdy, thick mounting base
- Dense foam

PART NO.	DESCRIPTION	RACER NET
AZ1632	Mini Bike Seat 12" Plush	\$24.71
AZ1633	Mini Bike Seat 19" Plush	32.21



## DEEP DRAWN STEEL FENDERS

- For 4", 5", & 6" wheels
- Plated or unplated
- Cold rolled steel

PART NO.	DESCRIPTION	RACER NET
AZ1855	4.5" x 14.5" unplated for 4" & 5" tires	\$6.71
AZ1857	4.5" x 14.5" plated for 4" & 5" tires	8.96
AZ1866	6.0" x 18" plated for 6" tires	13.47



## KICKSTAND

PART NO.	DESCRIPTION	RACER NET
AZ1727	Minibike Kickstand & Weldable Bracket	\$4.88
AZ1728	Bracket Only	1.13
AZ1729K	Kickstand Only	2.14

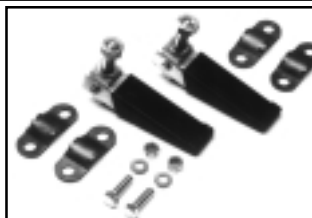

## FOLDING FOOT PEGS

- Long mounting studs
- Folds when not used
- Sturdy rubber treads

PART NO.	DESCRIPTION	RACER NET
AZ1740	1 pair folding foot pegs	\$5.21
AZ2239	1 pair folding foot pegs w/clamps	8.81

# MINI-BIKE, FUN KART & VINTAGE ACCESSORIES

ORDERS ONLY  
1-800-262-0555  
ALL QUESTIONS  
440-564-8100



## #41 CHAIN

PART NO.	LENGTH	RACER NET
AP1951	4 Foot	\$6.95
AP1952	10 Foot	19.85
AP2081	Master Link	1.04
AP2082	Offset Link	1.94

## #35 TYC SPACE CHAIN

PART NO.	DESCRIPTION	RACER NET
AZ4006X	10 Ft.#35 TYC Space Chain	\$30.38
AZ4390	3 Ft. #35 TYC Space Chain	8.96
AZ4391	4 Ft.#35 TYC Space Chain	12.71
AZ4007	#35 Master Link	.49

## STANDARD STEEL AXLES



- 1" diameter
  - 2 opposing offset 1/4" keyways
  - Stepped down threaded ends or snap ring:
    - Standard End:** 2" with 3/4" - 16 thread length of 1 3/8"
    - Short End:** 1 1/2" with 3/4" - 16 thread length of 1 1/8"
    - Snap Ring End:** No step or threads
- Lengths shown are overall measurements, including threads.*

PART NO.	DESCRIPTION	RACER NET
AZ8126	36" Standard end	\$33.38
AZ8153	36" Short end	33.38
AZ8121	38" Standard end	34.88
AZ8152	38" Short end	34.88
AZ8156	40" Standard end	36.38
AZ8150	40" Short end	36.38
AZ8192	42" Standard end	37.88
AZ8165	44" Standard end	39.38
AZ8166	54" Standard end	46.88
AZ8125	40" Snap ring end	36.38
AZ8343	Snap ring only	.25
G1297	1/4"x 1/4"x 12" Keystock	1.35
G1296	1/4"x 1/4"x 36" Keystock	4.67

## HARDWARE & BEARING KIT FOR LIVE AXLES

This kit includes everything needed to assemble a live axle to your frame/except the axle. The thick steel bearing hangers are designed to adapt to either the two or three hole bearing flangettes. For very long axles, an additional bearing hanger may be needed.



## KITS FOR 1" LIVE AXLES

DESCRIPTION	PART NO.	RACER NET
Kit w/ 2 Hole Flangettes	AZ1861A	\$28.46
Kit w/3 Hole Flangettes	AZ1861B	28.88

## COMPONENTS

DESCRIPTION	NEEDED	PART NO.	RACER NET
Bearings, Self-Aligning, w/Collars	2	AZ8211	\$6.71
Flangettes, 2 Hole	4	AZ8212	1.05
Flangettes, 3 Hole	4	AZ8213	1.13
Bearing Hangers, Slotted	2	AZ8127	2.97
Bolts 5/16-18 x 3/4	6	AZ8421	.25
Locknuts 5/16-18	6	AZ8510	.25
Locknuts 3/4-16	2	AZ8516	.53

## LOCKING COLLARS

These are the popular clamp design that firmly grip all around the shaft. Made from steel with black oxide finish and aluminum plain finish.

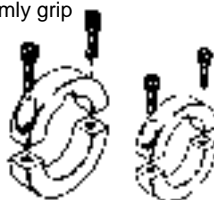

PART NO.	DESCRIPTION	RACER NET
H759100	1" bore two-piece steel 1/4" keyway	\$5.06
H759200	1 1/4" bore two-piece steel 1/4" keyway	5.63
H759300	1" bore two-piece aluminum 1/4" keyway	6.56
H759400	1 1/4" bore two-piece aluminum 1/4" keyway	4.95
AZ8555	5/8" One Piece Collar w/set screw	1.01
AZ8560	3/4" One Piece Collar w/set screw	1.24
AZ8551	3/4" Two Piece Steel Collar w/1/4" keyway	3.59
AZ8562	1/4" One Piece Collar w/set screw	.56
AZ8572	25mm Alum Two Piece Collar 6 & 8 keyway	6.94

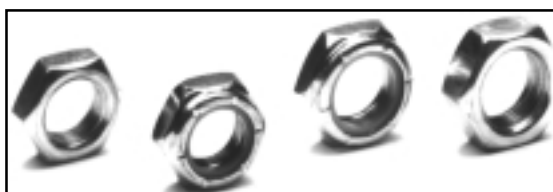

## AXLE NUTS

PART NO.	TYPE	THREAD	RACER NET
AZ8515	Locknut	5/8 - 18	\$.25
AZ8516	Locknut	3/4 - 16	.53
AZ8524	Jamnut	5/8 - 18	.30
AZ8525	Jamnut	3/4 - 16	.38

## STEEL AXLE

PART NO.	DESCRIPTION	RACER NET
AZ140541	3/4" x 41"	\$22.46



# FUN KART ACCESSORIES

## BRIGGS "FUN POWER" AIR FILTER ADAPTER

2 7/16" O.D.



PART NO.	DESCRIPTION	RACER NET
AP2236	Adapter only	\$8.21
AP1642	3 1/2"x 4" tapered filter	12.00

## BUCKET SEAT KIT

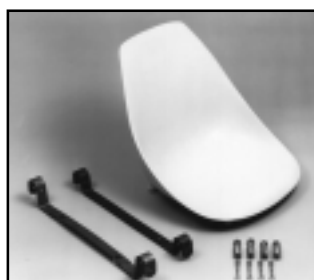

PART NO.	DESCRIPTION	RACER NET
AZ2290	Bucket Seat & Bracket kit (Less Upholstery)	\$59.21
AZ1645	Bucket Seat Cover	41.22

## POCKET BIKE CHAIN



#25 Heavy duty chain for Pocket Bikes and Scooters. Available in 10' rolls only.

PART NO.	DESCRIPTION	RACER NET
AZ480110	#25H Chain x 10' Roll	\$25.50
AZ4802	#25H Connecting Link	.45



## SHOCK ABSORBERS

PART NO.	DESCRIPTION	RACER NET
AZ170019	Adjustable Mechanical	\$18.38each
AZ1700230	Adjustable Hydraulic	29.96each
AZ1700236	Adjustable Hydraulic	29.96each

### SPECIFICATIONS -SHOCK ABSORBERS

PART	MAX INCHES COMPRESSION	TOTAL LOAD COMPRESSION	EYE TO EYE INCHES	TYPE
1700-19	2.0	450	12.0	Mech/Adj.
1700-230	2.4	650	12.0	Hydraulic
1700-236	2.4	730	12.0	Hydraulic



## TIRES & TUBES FOR POCKET BIKES & MOTORIZED SCOOTERS

*HOT! HOT! HOT! Pocket Bikes & Scooters are all the rage and our extensive line of compatible tires and tubes are in stock.*

TIRE PART NO.	SIZE	TREAD/PLY	RACER NET	TUBE PART NO.	RACER NET
AZ70712	200x50	Ribbed / 2	\$7.31	AZ7143	\$3.17
AZ7073	200x50	Sutdded / 4	7.31	AZ7143	3.17
AZ7053	9-350x4	Turf Saver / 4	9.85	AZ7128	5.63
AZ7090	9-350x4	Slick / 4	11.16	AZ7128	5.63
AZ7097	8-300x4	Slick / 4	11.21	AZ7129	4.62
AZ7077	300x4	Scooter / 2	11.21	AZ7128	5.63
AZ7074	410/350x5	Universal / 4	8.96	AZ7132	5.21
AZ7075	410/350x6	Universal / 4	14.96	AZ7133	4.79
AZ7078	410/350x4	Universal / 4	8.21	AP1917	5.03

# FUN KART TIRES, WHEELS & ACCESSORIES

ORDERS ONLY  
1-800-262-0555  
ALL QUESTIONS  
440-564-8100

## FUN KART TIRES & TUBES



Turf



Stud



Slick

PART NO.	DESCRIPTION	RACER NET
AP1905	410/350-4 2 ply stud tire	\$8.79
AP1906	410/350-4 4-ply slick tire	13.47
AP1907	410/350-4 turf tire	9.90
AP1908	410/350-5 2 ply stud tire	11.26
AP1909	410/350-5 4 ply slick tire	17.60
AZ7037	410/350-5 sawtooth tire	13.22
AP1910	11 x 400-5 turf tire	11.51
AP2552	11 x 600-5 4-ply super slick	36.72
AP1911	12x600-6 2 ply slick tire	26.63
AP1912	410/350-6 2 ply stud tire	11.00
AP1913	410/350-6 4 ply slick tire	24.38
AP1914	145/70-6 2 ply compass stud tire	21.46
AP1915	13x500-6 turf tire	15.02
AP1916	15 x600-6 2-ply flat track (turf) tire	22.56
AP1917	410/350-4 TR 87 tube only	5.03
AP1918	410/350-5 TR 87 tube only	5.19
AZ7133	410/350-6 TR 87 tube only	4.79
AP1920	15x600-6 TR 87 tube only	7.52
AZ7136	13x5x6 tube only	6.90
7161	11x4.0x5 tube only	6.12
7162	11x6.0x5 tube only	11.06

## 3-PIECE STEEL WHEELS



AZ1031



AZ1039

PART NO.	DESCRIPTION	RACER NET
<b>With 5/8" ID Bearings</b>		
AZ1031	4" Dia. x 2 1/4" Wide - 2 1/2" Hub w/ 2" Backset	\$14.44
AZ1033	5" Dia. x 2 3/4" Wide - 2 1/2" Hub w/ 2" Backset	19.62
AZ1035	6" Dia. x 2 3/4" Wide - 2 1/2" Hub w/ 2" Backset	21.38
<b>With Flange &amp; 5/8" ID Bearings</b>		
AZ1027	5" Dia. x 2 3/4" Wide - 2 5/8" Hub Length, w/ 2 1/4" Backset, Flange w/2" Backset	22.05
AZ1037	6" Dia. x 2 3/4" Wide - 2 5/8" Hub Length, w/ 2 1/4" Backset, Flange w/2" Backset	23.55
AZ1039	6" Dia. x 4 1/2" Wide - 3 1/2" Hub Length, w/ 3" Backset, Flange w/2 3/4" Backset	28.69
<b>Less Bearings (1 3/8" Bore)</b>		
AP5302	4" Dia x 3" width with 3 1/2" centered hub length	19.95
AP5304	6" Dia x 3 1/4" width with 3 3/4" centered hub length	27.95
AZ8205	5/8" ID x 1 3/8" OD bearing (sold each)	2.95
AZ8273	3/4" ID x 1 3/8" OD bearing (sold each)	4.46
<b>Sprockets &amp; Drums</b>		
AP1934	60 tooth sprocket for #35 chain	10.95
AP1935	72 tooth sprocket for #35 chain	12.95
AP1936	54 tooth sprocket for #41 chain	24.95
AP1938	4" I.D brake drum	5.28
* Indicates drive wheel with flange for sprocket or brake drum mounting.		

## 8" ALUMINUM TRI STAR WHEEL



PART NO.	DESCRIPTION	RACER NET
AZ1112	8" dia. x 3" wide w/5/8" ID sealed tapered roller bearings	\$49.46
AZ1113	8" dia. x 3" wide w/3/4" ID sealed tapered roller bearings	48.71
AZ1151	8" dia. x 3" wide w/3/4" ID sealed precision ball bearings	46.88
AZ1152	8" dia. x 3" wide w/5/8" ID sealed precision ball bearings	42.71

## STEEL WHEELS FOR 1" LIVE AXLES

(1" THRU BORE W/1/4" KEY WAY)



PART NO.	DESCRIPTION	RACER NET
AZ1030	4" Dia x 2.75" Width w/2.75" Hub Length	\$17.22
AZ1032	5" Dia x 2.75" Width w/2.75" Hub Length	21.72
AZ1034	6" Dia x 2.75" Width w/2.75" Hub Length	23.97

# VINTAGE / FUN KART WHEELS

## FOR 5/8" BALL BEARINGS

PART NO.	DESCRIPTION	RACER NET
AZ1144	Complete w/sealed precision bearings	\$24.38
AZ1146	Complete w/Standard ball bearings	24.38
AZ8205	Replacement Bearing 5/8" I.D. (each)	2.95

## FOR 1" LIVE AXLES

PART NO.	DESCRIPTION	RACER NET
AZ1147	With Steel Inserts-1" I.D., 1/4" keyway and 3/4" I.D. Step Down	\$28.13

## FOR TAPERED ROLLER BEARINGS

PART NO.	DESCRIPTION	RACER NET
AZ1140	Complete with 3/4" bearings	\$28.46
AZ1142	Less races, bearings, dust shields	19.88
AZ1135	Complete with 5/8" sealed tapered bearing	31.46
AZ1136	Complete with 3/4" sealed tapered bearing	30.72

## AZUSA 5" All-Aluminum Wheels



**\*\*Please note\*\***  
5" Diameter Azusa Aluminum  
Wheels are 3 1/4" wide.

## WHEEL SPACERS & BOLT KITS for 5" WHEELS

These Aluminum wheel spacers will fit all 5" Azusa Aluminum wheels. They are available in four widths.

PART NO.	DESCRIPTION	RACER NET
AZ1158	Wheel Spacer, 1/2" wide	\$6.71
AZ1159	Wheel Spacer, 1" wide	7.69
AZ1160	Wheel Spacer, 1 1/2" wide	8.63
AZ1161	Wheel Spacer, 2" wide	9.38

Grade 5 Cap Screws, 5/16" - 18 and mounting Locknuts. Six each, enough for two wheels. Lengths mate with wheel spacers.

PART NO.	DESCRIPTION	RACER NET
AZ1162	Bolt Kit for 1/2" Spacers	\$2.21
AZ1163	Bolt Kit for 1" Spacers	3.26
AZ1164	Bolt Kit for 1 1/2" Spacers	3.45
AZ1165	Bolt Kit for 2" Spacers	3.71

## AZUSA 6" All-Aluminum Wheels are 4" Wide



## FOR 5/8" BALL BEARINGS

PART NO.	DESCRIPTION	RACER NET
AZ1125	Complete w/sealed precision bearings	\$38.81
AZ1124	Less Bearings	35.96
AZ8205	Replacement Bearing 5/8" I.D. (each)	2.95

## FOR 1" LIVE AXLES

PART NO.	DESCRIPTION	RACER NET
AZ1117	With Steel Inserts - 1" I.D. w/ 1/4" keyway and 3/4" I.D. Step Down	\$40.46

## FOR TAPERED ROLLER BEARINGS

PART NO.	DESCRIPTION	RACER NET
AZ1106	With races, 3/4" bearings, dust shields	\$41.96
AZ1104	Complete with 5/8" sealed tapered bearing	44.21
AZ1105	Complete with 3/4" sealed tapered bearing	43.46



## TAPERED ROLLER BEARINGS

PART NO.	DESCRIPTION	RACER NET
AZ8203	Roller Unit (Cone) 3/4" I.D.	\$2.40
AZ8271	Reducer Bushing - 3/4" to 5/8"	.72
AZ8257	Race 1.785" O.D.	1.20
AZ8301	Dust Shield 3/4" I.D.	.28
AZ8305	Dust Shield 5/8" I.D.	.25
AZ8229	Sealed 3/4" Roller Unit.	3.71



## AZUSALITE WHEELS

- \* Specially engineered nylon Zytel® compound
- \* Corrosion-proof, solvent resistant
- \* Tough and lightweight
- \* Split-rim design
- \* Grade 5 hardware

PART NO.	DESCRIPTION	RACER NET
AZ1053	4" Dia. x 3" wide wheel w/5/8" precision bearings	\$14.21
AZ1054	4" Dia. x 3" wide wheel w/ 5/8" standard bearings	14.21
AZ1041	4" Dia. x 3" wide wheel w/ 3/4" standard bearings	13.46
AZ1065	5" Dia. x 4" wide wheel w/5/8" precision bearings	21.38
AZ1066	5" Dia. x 4" wide wheel w/ 5/8" standard bearings	20.22
AZ1070	5" Dia. x 4" wide wheel w/3/4" standard bearings	23.96
AZ1067	5" Dia. x 4" wide wheel fits 1" live axle w/3/4" step down	22.88
AZ1072	6" Dia. x 3" wide wheel w 5/8" precision bearings	23.96
AZ1073	6" Dia. x 3" wide wheel w/5/8" standard bearings	23.97
AZ1078	6" Dia. x 3" wide wheel w/3/4" standard bearings	23.21

## BRAKE PLATFORM

For Azusalite wheels only.

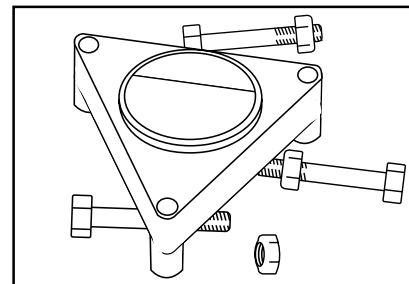

PART NO.	RACER NET
AZ2259A	\$5.63

# FUN KART WHEELS & TIRES

## "THE SPINNER" 8" CUSTOM ALUMINUM WHEEL



PART NO.	DESCRIPTION	RACER NET
AZ1175	8" Dia. x 3" Wide with 5/8" precision bearings	\$42.72
AZ1177	8" Dia. x 3" Wide with 3/4" standard bearings	41.97

## THE AZUSA "TEN-INCHER" STEEL WHEEL

Plated steel wheel with 5/8" precision bearings, split rim design for easy tire mounting.



PART NO.	DESCRIPTION	RACER NET
AZ10151	Basic Wheel	\$42.38
AZ10152	Wheel w/riveted brake drum	50.97
AZ10153	Wheel w/riveted brake drum flanged	50.97
AZ10154	Wheel w/riveted #35 sprocket & drum 60 tooth	54.72
AZ10155	Wheel w/riveted #35 sprocket & drum 70 tooth	58.47

## TIRES & TUBES



PART NO.	DESC.	RACER NET
AZ70102	480/400 x 8 Sawtooth / 2 Ply 4.6" Wide x 16" O.D.	\$24.04
AZ70042	480/400 x 8 Slick/ 2 Ply 4.6" Wide x 16.3" O.D.	15.38
AZ7020	250/275 x 10 Universal / 4 Ply 2.5" Wide x 15.3" O.D.	21.71
AZ7013	410/350 x 10 Universal / 4 Ply 3.7" Wide x 15.3" O.D.	26.21
AZ7121	480/400 Innertube / Straight stem	6.20
AZ7124	480/400 Innertube / Angled stem	7.13
AZ7126	250/10 Innertube / Straight stem	7.88
AZ7137	325/350 x 10 Innertube / Straight stem	8.06
AZ7150	8 x 1.25 Innertube / Inward Bent stem	4.46
AZ7151	10 x 2 Innertube / Straight stem	5.21

## SNOW HOG TIRES (Rim not included)

PART NO.	SIZE	RACER NET
AP2554	4.10 - 6	\$24.61
AP2555	13 x 5.00 - 6	27.96
AP2557	4.80 - 8	32.95
AP2558	16 x 6.50 - 8	39.95



## 4 on 4" 8" WHEELS & HUBS



PART NO.	DESCRIPTION	RACER NET
AP2301	8" dia. x 7" wide steel rim (4 on 4 bolt circle, 2.830" register)	\$25.13
AP2946	8" x 5 3/8" - Steel Rim (4 on 4" bolt circle)	19.46
AZ2282	Wheel Hub for 1" live axle with threaded ends. Has stepped bore with 1/4" keyway 4 on 4" bolt circle.	31.46
AZ2298	Wheel Hub for 3/4" tapered roller bearings. 4 on 4" bolt circle.	26.96
AZ8532	Lug Nuts 1/2" - 20	.38

## SUPER SLICK GO-KART TUBE TYPE TIRE

(Rim not included)

PART NO.	SIZE	RACER NET
AP2552	11 x 6.00 - 5 Slick	\$36.72
7162	11 x 6.00 - 5 Tube	11.06
AZ7066	13 x 6.50 - 6 Slick	24.99
AZ7136	13 x 5.00 - 6 Tube	6.90



# VINTAGE / FUN KART WHEEL & SPROCKET HUBS



Plated steel hub with 1/4" keyway securely mounts to an axle or shaft. With two mounting patterns, 4 holes on 2.875" & 4 holes on 3.228", Azusa brake drums or mini sprockets are easily mounted with the supplied hardware.

PART NO.	DESCRIPTION	RACER NET
AZ2568	3/4" Bore Mini Hub w/ 3/16" keyway	\$12.71
AZ1859	1" Bore Hub	12.71
AZ2566	1 1/4" Bore Hub	12.71
AZ2563	Hardware Kit	2.21

## 1" & 1 1/4" BORE STEEL SPROCKET HUBS PLATED-STEEL UNI-HUB

The UNI-HUB is designed for use as a sprocket and 6" drum carrier. Including all needed hardware, it weighs only 17 ounces. It's 5.25" six hole bolt circle heavy-duty steel plate is copper brazed to a steel hub with a 1" or 1 1/4" bore that has a 1/4" keyway.

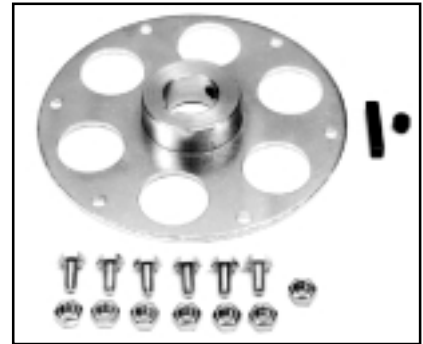

PART#	DESC.	RACER NET
AZ2555	1" Uni-hub w/Hardware	\$14.96
AZ2558	1 1/4" Uni-hub w/Hardware	14.96
AZ2557	Repl. Hardware kit	.98

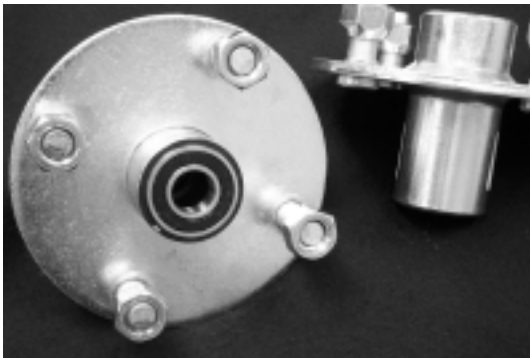

Hub with 3/4" ball bearings 4 bolts on 4" circle mounting pattern

PART NO.	RACER NET
AZ2296	\$29.63



Hub with 3/4" hole & 1" bore, 1/4" keyway use on axles with stepped ends 4 bolts on 4" circle mounting pattern

PART NO.	RACER NET
AZ2282	\$31.46

1" Thru Bore Hub

PART NO.	RACER NET
AZ2289	\$27.71

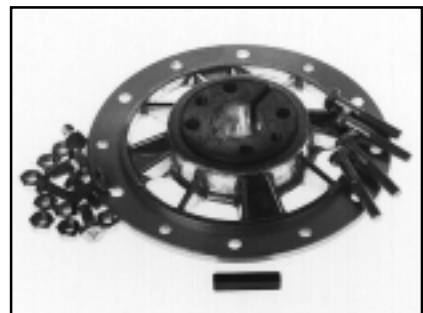

## MARK VI VARI-HUB

PART NO. AZ1872 - RACER NET: \$24.38

### DESCRIPTION

Mark VI Vari-Hub, 1" ID 1/4" Keyway Complete with Mounting-Hardware, Skin Packed.



Hub with 5/8" or 3/4" tapered roller bearings 4 bolts on 4" circle mounting pattern

PART NO.	DESC.	RACER NET
AZ2298	3/4"	\$26.96
AZ2299	5/8"	27.38

NOTE: All hubs sold each not as a pair

## HEAVY DUTY HUB FOR 1" LIVE AXLES, 1/4" KEYWAY

4" bolt circle-(4) 5/16" holes  
Nuts, bolts & setscrew included



PART NO.	RACER NET
AZ2286	\$17.96

# VINTAGE / FUN KART

## SPROCKETS #35

ORDERS ONLY  
1-800-262-0555  
ALL QUESTIONS  
440-564-8100



STYLE A



STYLE B

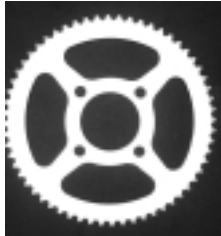

STYLE C



STYLE D

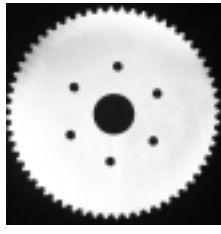

STYLE E

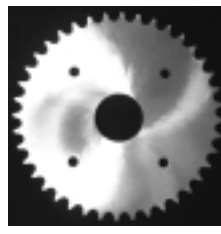

STYLE F

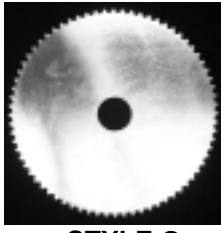

STYLE G

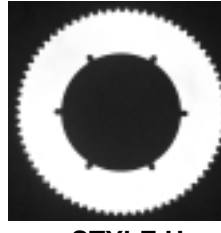

STYLE H



STYLE I

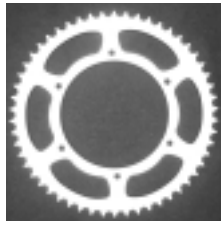

STYLE J

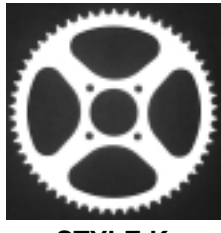

STYLE K

PART NO.	TEETH	CHAIN SIZE	STYLE	MATERIAL	MTG PATTERN		SPROCKET		
					(# Bolts/Circle Dia)	BORE	DIAMETER	RACER NET	
AZ2001	53	#35	A	ALUMINUM ALLOY	6 on 5 1/4"	4 9/16"	6.47"	\$15.30	
AZ2047	54	#35	A	ALUMINUM ALLOY	6 on 5 1/4"	4 9/16"	6.59"	15.30	
AZ2002	55	#35	A	ALUMINUM ALLOY	6 on 5 1/4"	4 9/16"	6.71"	15.30	
AZ2048	56	#35	A	ALUMINUM ALLOY	6 on 5 1/4"	4 9/16"	6.83"	15.30	
AZ2003	57	#35	A	ALUMINUM ALLOY	6 on 5 1/4"	4 9/16"	6.95"	15.30	
AZ2049	58	#35	A	ALUMINUM ALLOY	6 on 5 1/4"	4 9/16"	7.08"	15.30	
AZ2004	59	#35	A	ALUMINUM ALLOY	6 on 5 1/4"	4 9/16"	7.20"	15.30	
AZ2050	60	#35	A	ALUMINUM ALLOY	6 on 5 1/4"	4 9/16"	7.32"	15.30	
AZ2005	61	#35	A	ALUMINUM ALLOY	6 on 5 1/4"	4 9/16"	7.44"	16.17	
AZ2051	62	#35	A	ALUMINUM ALLOY	6 on 5 1/4"	4 9/16"	7.56"	16.17	
AZ2006	63	#35	A	ALUMINUM ALLOY	6 on 5 1/4"	4 9/16"	7.69"	16.17	
AZ2052	64	#35	A	ALUMINUM ALLOY	6 on 5 1/4"	4 9/16"	7.81"	16.17	
AZ2007	65	#35	A	ALUMINUM ALLOY	6 on 5 1/4"	4 9/16"	7.93"	16.17	
AZ2053	66	#35	A	ALUMINUM ALLOY	6 on 5 1/4"	4 9/16"	8.05"	16.17	
AZ2008	67	#35	A	ALUMINUM ALLOY	6 on 5 1/4"	4 9/16"	8.17"	16.17	
AZ2054	68	#35	A	ALUMINUM ALLOY	6 on 5 1/4"	4 9/16"	8.30"	16.17	
AZ2009	69	#35	A	ALUMINUM ALLOY	6 on 5 1/4"	4 9/16"	8.42"	17.97	
AZ2055	70	#35	A	ALUMINUM ALLOY	6 on 5 1/4"	4 9/16"	8.54"	17.97	
AZ2010	71	#35	A	ALUMINUM ALLOY	6 on 5 1/4"	4 9/16"	8.66"	17.97	
AZ2056	72	#35	A	ALUMINUM ALLOY	6 on 5 1/4"	4 9/16"	8.78"	17.97	
AZ2011	73	#35	A	ALUMINUM ALLOY	6 on 5 1/4"	4 9/16"	8.91"	17.97	
AZ2057	74	#35	A	ALUMINUM ALLOY	6 on 5 1/4"	4 9/16"	9.03"	17.97	
AZ2012	75	#35	A	ALUMINUM ALLOY	6 on 5 1/4"	4 9/16"	9.15"	17.97	
AZ2058	76	#35	A	ALUMINUM ALLOY	6 on 5 1/4"	4 9/16"	9.27"	17.97	
AZ2013	77	#35	A	ALUMINUM ALLOY	6 on 5 1/4"	4 9/16"	9.39"	17.97	
AZ2059	78	#35	A	ALUMINUM ALLOY	6 on 5 1/4"	4 9/16"	9.52"	19.50	
AZ2014	79	#35	A	ALUMINUM ALLOY	6 on 5 1/4"	4 9/16"	9.64"	19.50	
AZ2060	80	#35	A	ALUMINUM ALLOY	6 on 5 1/4"	4 9/16"	9.76"	19.50	
AZ2061	82	#35	A	ALUMINUM ALLOY	6 on 5 1/4"	4 9/16"	10.00"	19.50	
AZ2062	84	#35	A	ALUMINUM ALLOY	6 on 5 1/4"	4 9/16"	10.25"	19.50	
AZ216460	60	#35	C	STEEL	4 on 2 7/8"	2"	7.32"	17.96	
AZ216466	66	#35	C	STEEL	4 on 2 7/8"	2"	8.05"	19.13	
AZ216472	72	#35	C	STEEL	4 on 2 7/8"	2"	8.78"	19.69	
AZ216560	60	#35	D	STEEL	4 on 4"	1.5"	7.32"	17.96	
AZ216572	72	#35	D	STEEL	4 on 4"	1.5"	8.78"	19.69	
AZ2155	60	#35	E	STEEL	6 ON 3 1/4"	1.375"	7.32"	8.96	
AZ2157	72	#35	G	STEEL	NONE (BLANK)	1.375"	8.78"	10.88	
AZ2161	72	#35	E	STEEL	6 ON 3 1/4"	1.375"	8.78"	10.88	
AZ2158	72	#35	H	STEEL	6 on 5 1/4"	4 13/16"	8.78"	10.88	
AZ2084	37	#35	B	ALUMINUM ALLOY	4 on 3.228" **	2 1/8"	4.51"	11.06	
AZ2085	38	#35	B	ALUMINUM ALLOY	4 on 3.228" **	2 1/8"	4.64"	11.06	
AZ2086	39	#35	B	ALUMINUM ALLOY	4 on 3.228" **	2 1/8"	4.76"	11.06	
AZ2087	40	#35	B	ALUMINUM ALLOY	4 on 3.228" **	2 1/8"	4.88"	11.06	
AZ2088	41	#35	B	ALUMINUM ALLOY	4 on 3.228" **	2 1/8"	5.00"	11.96	
AZ2089	42	#35	B	ALUMINUM ALLOY	4 on 3.228" **	2 1/8"	5.12"	11.96	
AZ2090	43	#35	B	ALUMINUM ALLOY	4 on 3.228" **	2 1/8"	5.25"	11.96	
AZ2091	44	#35	B	ALUMINUM ALLOY	4 on 3.228" **	2 1/8"	5.37"	11.96	
AZ2092	45	#35	B	ALUMINUM ALLOY	4 on 3.228" **	2 1/8"	5.49"	13.88	
AZ2093	46	#35	B	ALUMINUM ALLOY	4 on 3.228" **	2 1/8"	5.61"	13.88	
AZ2094	47	#35	B	ALUMINUM ALLOY	4 on 3.228" **	2 1/8"	5.73"	13.88	
AZ2095	48	#35	B	ALUMINUM ALLOY	4 on 3.228" **	2 1/8"	5.86"	13.88	
AZ2096	49	#35	B	ALUMINUM ALLOY	4 on 3.228" **	2 1/8"	5.98"	15.71	
AZ2097	50	#35	B	ALUMINUM ALLOY	4 on 3.228" **	2 1/8"	6.10"	15.71	
AZ2098	51	#35	B	ALUMINUM ALLOY	4 on 3.228" **	2 1/8"	6.22"	15.71	
AZ2099	52	#35	B	ALUMINUM ALLOY	4 on 3.228" **	2 1/8"	6.34"	15.71	
AP1934	60	#35	I	STEEL	4 on 2 7/8" & 3 1/2"	2 1/8"	7.32"	10.95	
AP1935	72	#35	I	STEEL	4 on 2 7/8" & 3 1/2"	2 1/8"	8.78"	12.95	

\*\* NOT SYMMETRICAL FITS AZ1859 & AZ2566 HUBS ONLY

# VINTAGE / FUN KART SPROCKETS #40/41



STYLE A



STYLE B



STYLE C



STYLE D

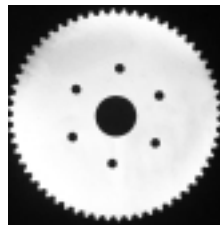

STYLE E

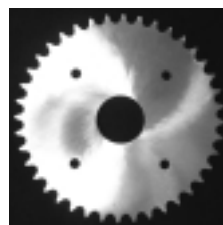

STYLE F

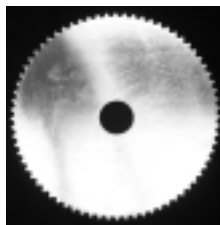

STYLE G

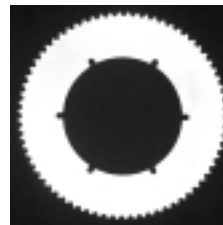

STYLE H



STYLE I

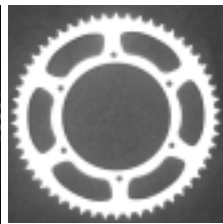

STYLE J

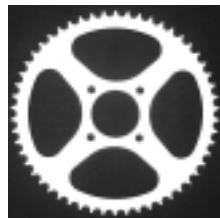

STYLE K

PART NO.	TEETH	CHAIN SIZE	STYLE	MATERIAL	MTG PATTERN (# Bolts/Circle Dia)	BORE	DIAMETER	RACER NET
AZ531440	40	#40/41	F	ALUMINUM ALLOY	4 on 4"	1 1/2"	6.52"	22.69
AZ531442	42	#40/41	F	ALUMINUM ALLOY	4 on 4"	1 1/2"	6.85"	27.94
AZ531444	44	#40/41	F	ALUMINUM ALLOY	4 on 4"	1 1/2"	7.17"	27.94
AZ531446	46	#40/41	F	ALUMINUM ALLOY	4 on 4"	1 1/2"	7.50"	27.94
AZ531448	48	#40/41	F	ALUMINUM ALLOY	4 on 4"	1 1/2"	7.82"	27.94
AZ531450	50	#40/41	F	ALUMINUM ALLOY	4 on 4"	1 1/2"	8.15"	34.31
AZ531452	52	#40/41	F	ALUMINUM ALLOY	4 on 4"	1 1/2"	8.48"	34.31
AZ531454	54	#40/41	F	ALUMINUM ALLOY	4 on 4"	1 1/2"	8.80"	34.31
AZ531456	56	#40/41	F	ALUMINUM ALLOY	4 on 4"	1 1/2"	9.13"	34.31
AZ531458	58	#40/41	F	ALUMINUM ALLOY	4 on 4"	1 1/2"	9.45"	34.31
AZ531460	60	#40/41	F	ALUMINUM ALLOY	4 on 4"	1 1/2"	9.78"	41.63
AZ531443S	40	#40/41	A	ALUMINUM ALLOY	6 on 5 1/4"	4 9/16"	6.52"	22.69
AZ531441S	41	#40/41	A	ALUMINUM ALLOY	6 on 5 1/4"	4 9/16"	6.68"	27.94
AZ531442S	42	#40/41	A	ALUMINUM ALLOY	6 on 5 1/4"	4 9/16"	6.85"	27.94
AZ531443S	43	#40/41	A	ALUMINUM ALLOY	6 on 5 1/4"	4 9/16"	7.00"	27.94
AZ531444S	44	#40/41	A	ALUMINUM ALLOY	6 on 5 1/4"	4 9/16"	7.17"	27.94
AZ531445S	45	#40/41	A	ALUMINUM ALLOY	6 on 5 1/4"	4 9/16"	7.33"	27.94
AZ531446S	46	#40/41	A	ALUMINUM ALLOY	6 on 5 1/4"	4 9/16"	7.50"	27.94
AZ531447S	47	#40/41	A	ALUMINUM ALLOY	6 on 5 1/4"	4 9/16"	7.66"	27.94
AZ531448S	48	#40/41	A	ALUMINUM ALLOY	6 on 5 1/4"	4 9/16"	7.82"	27.94
AZ531449S	49	#40/41	A	ALUMINUM ALLOY	6 on 5 1/4"	4 9/16"	7.99"	34.31
AZ531450S	50	#40/41	A	ALUMINUM ALLOY	6 on 5 1/4"	4 9/16"	8.15"	34.31
AZ531451S	51	#40/41	A	ALUMINUM ALLOY	6 on 5 1/4"	4 9/16"	8.31"	34.31
AZ531452S	52	#40/41	A	ALUMINUM ALLOY	6 on 5 1/4"	4 9/16"	8.48"	34.31
AZ531453S	53	#40/41	A	ALUMINUM ALLOY	6 on 5 1/4"	4 9/16"	8.64"	34.31
AZ531454S	54	#40/41	A	ALUMINUM ALLOY	6 on 5 1/4"	4 9/16"	8.80"	34.31
AZ531455S	55	#40/41	A	ALUMINUM ALLOY	6 on 5 1/4"	4 9/16"	8.96"	34.31
AZ531456S	56	#40/41	A	ALUMINUM ALLOY	6 on 5 1/4"	4 9/16"	9.13"	34.31
AZ531457S	57	#40/41	A	ALUMINUM ALLOY	6 on 5 1/4"	4 9/16"	9.29"	34.31
AZ531458S	58	#40/41	A	ALUMINUM ALLOY	6 on 5 1/4"	4 9/16"	9.45"	34.31
AZ531459S	59	#40/41	A	ALUMINUM ALLOY	6 on 5 1/4"	4 9/16"	9.62"	41.63
AZ531460S	60	#40/41	A	ALUMINUM ALLOY	6 on 5 1/4"	4 9/16"	9.78"	41.63
AZ531461S	61	#40/41	A	ALUMINUM ALLOY	6 on 5 1/4"	4 9/16"	9.94"	41.63
AZ531462S	62	#40/41	A	ALUMINUM ALLOY	6 on 5 1/4"	4 9/16"	10.11"	41.63
AZ531463S	63	#40/41	A	ALUMINUM ALLOY	6 on 5 1/4"	4 9/16"	10.27"	41.63
AZ531464S	64	#40/41	A	ALUMINUM ALLOY	6 on 5 1/4"	4 9/16"	10.43"	41.63
AZ531465S	65	#40/41	A	ALUMINUM ALLOY	6 on 5 1/4"	4 9/16"	10.60"	41.63
AZ531466S	66	#40/41	A	ALUMINUM ALLOY	6 on 5 1/4"	4 9/16"	10.76"	41.63
AZ531467S	67	#40/41	A	ALUMINUM ALLOY	6 on 5 1/4"	4 9/16"	10.92"	41.63
AZ531468S	68	#40/41	A	ALUMINUM ALLOY	6 on 5 1/4"	4 9/16"	11.08"	44.44
AZ531469S	69	#40/41	A	ALUMINUM ALLOY	6 on 5 1/4"	4 9/16"	11.25"	44.44
AZ531470S	70	#40/41	A	ALUMINUM ALLOY	6 on 5 1/4"	4 9/16"	11.41"	44.44
AZ216654	54	#40/41	J	STEEL	6 on 5 1/4"	4 9/16"	8.80"	22.47
AZ216660	60	#40/41	J	STEEL	6 on 5 1/4"	4 9/16"	9.78"	29.22
AZ216754	54	#40/41	K	STEEL	4 on 2 7/8"	2"	8.80"	22.46
AZ216854	54	#40/41	D	STEEL	4 on 4"	1 1/2"	8.80"	22.46

\*\* NOT SYMMETRICAL FITS AZ1859 & AZ2566 HUBS ONLY

\*\* NOT SYMMETRICAL FITS AZ1859 & AZ2566 HUBS ONLY

# VINTAGE / FUN KART BRAKES & SPROCKETS

ORDERS ONLY  
1-800-262-0555  
ALL QUESTIONS  
440-564-8100



## 4 1/2" DIA. MINI BIKE/ KART BRAKES



## 4-1/2" BRAKE DRUMS



Built in two styles, front-wheel (flangeless) drum and rear wheel drum with mounting flange for sprockets. Both are "sized" for perfect concentricity and even contact with Azusa's internal expanding 4-1/2" Brake Assembly.

PART NO	DESCRIPTION	RACER NET
AZ2208	Brake Assy, W/ 5/8" Axle Hole in Backing Plate	\$27.71
AZ2269	Brake Assy, W/1" Axle Hole in Backing Plate	28.46
AZ2260	Lined Brake Shoes (1 Set)	12.71
AZ8321	Spacer - Use to space Brake Backing Plate from AZUSA Wheel and Drum assembly	1.88

PART NO.	DESCRIPTION	RACER NET
AZ2270A	Aluminum Backing Plate, 5/8" Bore	\$27.71
AZ2271S	Steel Backing Plate, 1" Bore	27.71
AZ2271A	Aluminum Backing Plate, 1" Bore	27.71

PART NO.	DESCRIPTION	RACER NET
AZ2211	Front Wheel Brake Drum, Plated	\$10.13
AZ2213	Rear Wheel Flanged Brake Drum Plated	8.21
AZ1859	Hub for 1" Live Axle	12.71

## STEEL SPROCKET & DRUM ASSEMBLIES



Our 4-1/2" Brake Drum/Sprocket Holder and our 60 or 72 tooth solid steel sprockets produce a strong, reliable unit at very economical prices. Three and four hole bolt pattern fits Azusa's 5", 6" and 10" wheels, and can be adapted to fit most other brands.

#35 Chain Only!

PART NO.	DESCRIPTION	RACER NET
AZ2217	Drum & 60 Tooth Sprocket	\$17.96
AZ2218	Drum & 72 Tooth Sprocket	20.21

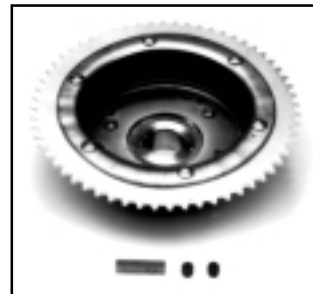

## ECONOMY BRAKE/DRUM/ SPROCKET ASSEMBLY

A great way to buy a drive/brake combination. USES AZ2269, AZ2271S, or AZ2271A Brakes. Brakes sold separately.



PART NO.	DESCRIPTION	RACER NET
AZ2265	4-1/2" Drum No Flange w/1" Hub	\$19.31
AZ2266	4-1/2" Flanged Drum w/1" Hub	17.81
AZ2267	4-1/2" Drum & 60T Sprocket w/1" Hub	28.46
AZ2268	4-1/2" Drum & 72T Sprocket w/1" Hub	29.96
AZ2245	4-1/2" Drum, No Flange w/1 1/4" Hub	19.31
AZ2246	4-1/2" Flanged Drum w/1 1/4" Hub	19.31
AZ2247	4-1/2" Drum & 60T Sprocket w/1 1/4" Hub	24.38
AZ2248	4-1/2" Drum & 72T Sprocket w/1 1/4" Hub	26.96

## AZUSA 6" INTERNAL EXPANDING BRAKE



DESCRIPTION	PART NO.	RACER NET
Complete Brake 1" Axle .....	AZ2550A .....	\$78.71
Complete Brake 1" Axle w/Spacer Kit ..	AZ2552 .....	83.21
Complete Brake 1 1/4" Axle .....	AZ2547 .....	74.21
6" Brake Only Less Drum .....	AZ2550 .....	47.21
Drum Only, Unplated, 4-9/16" Bore .....	AZ8138 .....	12.18
Drum Only, Plated, 4-9/16" Bore .....	AZ8139 .....	16.47
Drum Unplated w/Riveted 1" Hub .....	AZ8149 .....	21.71
Drum Plated w/Riveted 1" Hub .....	AZ8142 .....	35.21
Drum Unplated w/Riveted 1 1/4" Hub ..	AZ8146 .....	35.21
Drum Plated w/Riveted 1 1/4" Hub .....	AZ8141 .....	35.21
Azusa Shoes w/Bonded Lining, 1 Pr. ...	AZ8101 .....	17.81
Spring, Short .....	AZ8455 .....	1.02
Spring, Long .....	AZ8456 .....	1.31
Brake Arm .....	AZ8147 .....	10.46
Brake Cam .....	AZ8148 .....	6.71

## SPACER - BRAKE TO HANGER

This die-cast spacer secures the Bendix Brake accurately to the frame hanger. It is designed to adapt to either the two or three hole flanges.



PART NO.	DESCRIPTION	RACER NET
AZ1860	Spacer - Brake to Hanger	\$3.94
AZ8466	Bolt 5/16 - 18 x 3 1/4"	.35
AZ8510	Lock nuts 5/16 - 18	.25

# VINTAGE / FUN KART & MINI BIKE BRAKES & SPROCKETS

## 4" & 4 1/2" MACHINED OD DRUMS

Part No.	Description	Racer Net
AZ2541	4" O.D. Brake Drum (No Flange) 4 Holes 5/16" & 3/8" Dia. on a 2 7/8" Bolt Circle	\$5.96
AZ2211OD	4 1/2" O.D. (No Flange)	10.13
AZ2213OD	4 1/2" O.D. (w/ Flange)	9.71



## 4 1/2" MACHINED O.D. SPROCKET/DRUMS

Part No.	Description	Racer Net
AZ2217OD	4 1/2" O.D. w/60 Tooth #35 Sprocket	\$19.46
AZ2218OD	4 1/2" O.D. w/72 Tooth #35 Sprocket	21.71



## 4 1/2" MACHINED O.D. DRUMS & SPROCKETS/DRUMS W/RIVETED HUB FOR 1" & 1 1/4" AXLES

Part No.	Description	Racer Net
AZ2265OD	4-1/2" Drum, No Flange w/1" Hub	\$19.31
AZ2266OD	4-1/2" Flanged Drum w/1" Hub	17.81
AZ2267OD	4-1/2" Drum & 60T Sprocket w/1" Hub	32.06
AZ2268OD	4-1/2" Drum & 72T Sprocket w/1" Hub	31.46
AZ2245OD	4-1/2" Drum, No Flange w/1 1/4" Hub	19.31
AZ2246OD	4-1/2" Flanged Drum w/1 1/4" Hub	19.31
AZ2247OD	4-1/2" Drum & 60T Sprocket w/1 1/4" Hub	27.38
AZ2248OD	4-1/2" Drum & 72T Sprocket w/1 1/4" Hub	31.46

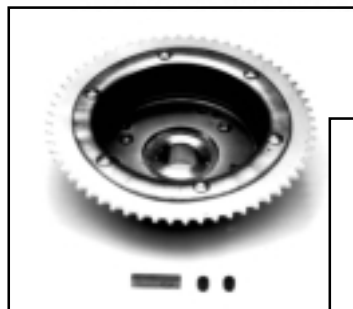

## 4" & 4 1/2" BRAKE BANDS

Part No.	Description	Racer Net
AZ2251	4" Brake Band w/Cable Pin	\$10.17
AZ2255	4 1/2" Brake Band w/Cable Pin	11.44
AZ2254	Replacement Cable Pin	1.35



## DISC BRAKE WITH PADS

Replaces Manco 3759

Used on Riding Mowers, Minibikes, and Go Karts



Part No.	Description	Racer Net
AP1797	Caliper Assembly	\$19.95
AP1798	Replacement pad set	3.95
AZ1823	Disc only, 8" dia. 1" bore	20.21

## POSI-STOP DISC BRAKE

- All self contained • U.S. Patent 3,003,589
- Dual pads of molded lining
- Self-aligning to disc
- Keyway for live axle mounting



PART NO.	DESCRIPTION	RACER NET
AZ1822	Brake Assembly W/O Disc	\$32.96
AZ1823	Disc Only, 8" Dia., 1" Bore	20.21
AZ8118	Replacement pad (2 required)	4.73



## DISC BRAKE

PART NO.	RACER NET
AP5268	\$27.95

# VINTAGE / FUN KART SPINDLES & TIE RODS

ORDERS ONLY  
1-800-262-0555  
ALL QUESTIONS  
440-564-8100

## TIE RODS

These tie rods are made from steel with extra long threads in case you need to shorten them. Plated with fine thread. Jam Nut included in Kit.

### ECONOMY FEMALE ROD ENDS

PART NO.	DESCRIPTION	RACER NET
AZ8220	Female 5/16 - 24 RH	\$2.74
AZ8243	Female 3/8 - 24 RH	2.95

### QUALITY FEMALE ROD ENDS

PART NO.	DESCRIPTION	RACER NET
AZ8221	Female 5/16 - 24 RH	\$3.99
AZ8244	Female 3/8 - 24 RH	4.99



### TIE RODS W/ECONOMY ROD END BEARINGS

PART NO.	DESCRIPTION	RACER NET
AZ1837	11" tie rod w/ 5/16 - 24 rod ends	\$7.69
AZ1838	15" tie rod w/ 5/16 - 24 rod ends	8.06
AZ1839	24" tie rod w/ 5/16 - 24 rod ends	8.96
AZ2215	13" tie rod w/ 3/8 - 24 rod ends	9.71

### PLATED TIE RODS

PART NO.	DESCRIPTION	RACER NET
AZ8228	5/16 - 24 x 11	\$2.21
AZ8223	5/16 - 24 x 15	2.63
AZ8226	5/16 - 24 x 24	3.71
AZ8242	3/8 - 24 x 13	3.56

### TIE RODS W/QUALITY ROD END BEARINGS

PART NO.	DESCRIPTION	RACER NET
AZ1847	11" tie rod w/ 5/16 - 24 rod ends	\$13.13
AZ1888	15" tie rod w/ 5/16 - 24 rod ends	13.46
AZ1889	24" tie rod w/ 5/16 - 24 rod ends	14.21
AZ2214	13" tie rod w/ 3/8 - 24 rod ends	14.97

### JAM NUTS

PART NO.	DESCRIPTION	RACER NET
AZ8523	5/16 - 24 RH	\$.25
AZ8512	3/8 - 24 RH	.25
AZ8529	5/16 - 24 LH	.42
AZ8530	3/8 - 24 LH	.53

### SPINDLE & BRACKET SETS COMPLETE



Jig-welded for consistency

DESCRIPTION	SIDE 1	SIDE 2	RACER NET
5/8 x 3 3/4	AZ2204	AZ2205	\$12.94
5/8 x 4 1/2	AZ2235	AZ2236	13.31
5/8 x 6	AZ2512	AZ2513	13.88
3/4 x 3 3/4	AZ2200	AZ2201	14.63
3/4 x 4 1/2	AZ2231	AZ2232	14.96
3/4 x 6	AZ2516	AZ2517	15.56

### WELDED SPINDLES ONLY (LESS BRACKET)

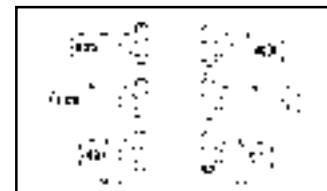

DESCRIPTION	SIDE 1	SIDE 2	RACER NET
5/8 x 3 3/4	AZ2206	AZ2207	\$8.21
5/8 x 4 1/2	AZ2237	AZ2238	8.63
3/4 x 3 3/4	AZ2202	AZ2203	9.71
3/4 x 4 1/2	AZ2233	AZ2234	10.13
5/8 x 6	AZ2514	AZ2515	9.19
3/4 x 6	AZ2518	AZ2519	10.46

### COMPONENTS

PART NO.	DESCRIPTION	RACER NET
AZ8171	Spindle Bracket (Holder) 5/8" bore	\$2.95
AZ8172	Spindle Arm w/Hole - Side 1	1.13
AZ8173	Spindle Arm w/Hole - Side 2	1.13
AZ8447	Kingpin Bolt - 5/8 - 18 x 3 3/4	1.35
AZ8327	Steel Spacer 11/16" x 1" OD x 2 1/2"	3.38
AZ8328	Plastic Spacer - 5/8" ID	.30
AZ8329	Plastic Spacer - 3/4" ID	.32
AZ8215	Nyliner Bushing, 5/8 ID x 11/16 OD	.45
AZ8515	Locknut, 5/8 - 18	.25
AZ8516	Locknut, 3/4 - 16	.53
AZ8181	Spindle bracket for 1/2" king pin	2.96
AZ8446	Kingpin bolt 1/2-20 x 3 3/4	1.02
AZ8514	Locknut 1/2-20	.25

# BOOKS

## BEGINNER'S GUIDE BOOK



This is currently the only complete and practical guide to karting for the beginner. By Jean Genibrel, includes more than 100 photos with information on everything the novice needs to know to begin racing.

<b>PART NO.</b> W4013	<b>RACER NET</b> \$16.95
--------------------------	-----------------------------

**Sorry no returns on books**

## 2011 TECH MANUAL



<b>PART NO.</b> TECH11	<b>RACER NET</b> \$25.00
---------------------------	-----------------------------

**Sorry no returns on books**

## 4-CYCLE KARTING TECHNOLOGY

This new book is oriented to the special needs of 4-stroke engine kart racers, plus it covers tech topics important to all karters. Contents include:



- Engine building and blueprinting
- Fuel systems
- Carb jetting and fine tuning
- Camshafts
- Ignition systems
- Gear ratios
- Aerodynamics
- Using twin engines
- Handling and adjustment
- Front alignment
- Tire stagger
- Competition driving tips
- And more

Hundreds of tips and tricks to make a kart run faster and live longer. 80 pages, over 200 photos

<b>PART NO.</b> AP1043	<b>RACER NET</b> \$16.95
---------------------------	-----------------------------

Author: Bill Starrett  
 ISBN Number: 0-936834-63-3

**Sorry no returns on books**

## QUARTER MIDGET CHASSIS TECHNOLOGY

*By Steve Smith*

A complete chassis tuning and setup guide for quarter midgets. Chapters include:

- Race car handling basics
- Suspension systems
- Shock absorbers
- Tires and wheels
- Chassis setup and alignment
- Track tuning and adjustment

Includes a complete guide to understanding and adjusting handling problems. Everything you need to know to get your car competitive. Applies to both paved and dirt tracks.



<b>PART NO.</b> AP4600	<b>RACER NET</b> \$29.95
---------------------------	-----------------------------

**Sorry no returns on books**

## THE ORIGINAL BRIGGS & STRATTON SERVICE MANUAL



Covers all models. Contains specifications, illustrations for operations, special tool part #, and theories of operation.

PART NO.	DESCRIPTION	RACER NET
BS270962	"L" Head Engine	\$16.35
BS272147	"OHV" Engines	16.35

**Sorry no returns on books**

## KART DRIVING TECHNIQUES

*By Jim Hall II, owner of Jim Hall Kart Racing School*

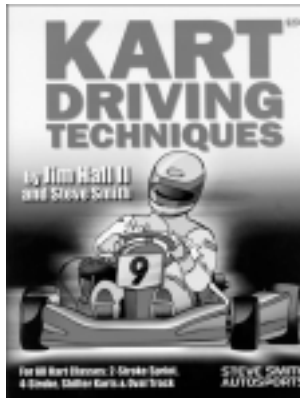

A world-class driver and instructor teaches you the fundamentals of going fast in any type of kart. Includes: Understanding kart cornering dynamics, how to learn the proper line, prioritizing a track, learning braking finesse, how to master trail braking, techniques that give any racer that extra edge, racing and passing strategies, getting out of trouble, the mental approach to racing, and much more. There are tips and techniques to help all drivers from novice to expert. Includes a chapter on shifter kart techniques. Fully illustrated with photos and drawings.

<b>PART NO.</b> AP2772	<b>RACER NET</b> \$16.46
---------------------------	-----------------------------

**Sorry no returns on books**

## KART CHASSIS SETUP TECHNOLOGY

Kart Chassis Setup Technology furnishes comprehensive details on chassis setup and teaches a racer the easiest and best way to prepare a kart for competition.

The book includes:

- Understanding a kart chassis - how torsional flex influences handling
- Chassis & handling dynamics - what affects handling and weight transfer
- Front end geometry - the principles of caster, camber, toe, Ackerman, steering axis and scrub radius, and how they affect kart handling
- Chassis baseline setup - kart scaling and weight distribution, proper seat positioning
- Tires - theory, use, compounds, pressures, reading tires
- Track tuning and adjustment - dialing in the chassis at the track
- Dirt track setup and adjustments weight distribution, cross weight, stagger, chassis adjustment for wet, tacky and dry slick tracks



<b>PART NO.</b> AP4175	<b>RACER NET</b> \$21.95
---------------------------	-----------------------------

**Sorry no returns on books**

Whether you race 2-Cycle or 4, Sprint or Oval, Asphalt or Dirt, this book will help you maximize your kart's handling and performance.

**TERMS AND ORDERING INFORMATION  
CALL TOLL FREE  
ORDERS ONLY  
DIRECT ORDER ENTRY LINE**

**1-800-262-0555**

**Parts Information and Customer Service  
1-440-564-8100**

**Same day shipping on orders placed before 3:00 p.m. Eastern time.**

**ORDER HOURS:**

**8:30 a.m. to 5:00 p.m. Mon. - Thurs.**

**8:30 a.m. to 4:00 p.m. Friday.**

**Closed Saturdays, Sundays & Holidays**

**On-line Ordering with current pricing & availability at  
[www.apsorderonline.com](http://www.apsorderonline.com) • 24 hours a day • 7 days a week**

**DIRECT PARTS ORDER ENTRY**

To give our customers faster and more efficient service, we have programmed our computer and trained our telephone operators to enter orders directly into our computer system. This enables our telephone operators to check stock and current pricing for you immediately as you order. To take advantage of our Direct Order Entry Service, please use the following steps when ordering:

- (1) Call our Toll Free Direct Order Entry Line
- (2) Give the operator your assigned Customer Number. The operator will then verify your shipping address. New customers please see below.
- (3) Tell the operator if you would like your order shipped Ground or Special Service and state how you would like to pay for the order: **Certified check or money order**, VISA, MasterCard, Discover or American Express.
- (4) Give the operator **THE PART NUMBER YOU WISH TO ORDER FIRST** and then the quantity you need. The operator will then verify availability and current pricing.

If you are a new customer and have all your part numbers, please call our Toll Free Direct Order Line and tell the operator this is your first order. They will then assign you your American Power Sports Customer Number and take your order.

**PARTS INFORMATION AND CUSTOMER SERVICE** If you do not have part numbers, or have questions about parts applications, please call our Parts Information/Customer Service Number (1-440-564-8100). If you have a problem with an order, need to check when an order was shipped, or have other questions concerning your order, please call our Parts Information/Customer Service Number (1-440-564-8100). **Our Direct Order Operators do not have the information available to properly assist you with Parts or Customer Service Questions.**

**ADD-ONS OR CHANGES TO AN ORDER** Because of the speed of our direct order entry system, it is **not** possible to add-on to, cancel, or change an order once it has been placed. All calls to add-on to an order will be treated as a separate order and are subject to our normal ordering policies and terms.

**TO AVOID ADDITIONAL SHIPPING & HANDLING CHARGES, PLEASE MAKE SURE YOUR ORDER IS COMPLETE BEFORE CALLING OUR ORDER LINE.**

**FOREIGN ORDERS** Orders being shipped to points other than the United States, Canada, or Puerto Rico must be Paid in Advance in U.S. funds with a money order or certified check (Sorry no credit cards). Minimum order for shipment is \$500.00.

**Copyright © 2011 American Power Sports**

*All rights reserved. Reproduction of this catalog in whole or part without written permission is prohibited by law.*

**BACK ORDERS** Items that we do not have in stock at the time your order is shipped can be placed on back order at the customer's request. All back orders are cancelled after 30 days. (Sorry, no COD backorders). Customer is responsible for shipping charges on the original order only. Backorders will be shipped **freight free** unless the backordered item or items are the only item or items on the initial order.

**RETURNS** You may return any unused item within 30 DAYS of purchase. NO Return Authorization is needed but the return must be made WITHIN 30 DAYS of the invoice date. Simply return the item with a copy of the invoice and a brief note explaining the reason for the return. Please include a daytime phone number on the note in case there are any questions concerning your return. Items must be returned in NEW or UNUSED condition. Please take care to properly package the item so that it will not be damaged in shipment. Items damaged during return shipping due to improper packaging will NOT be accepted. American Power Sports reserves the right to refuse any item for return. If you have any questions about returning an item please call Customer Service at 440-564-8100.

Returns can only be processed as a credit to the credit card used on the original purchase invoice. If you need to reorder a replacement item please call the order in to 800-262-0555 or place the order on-line at [www.apsorderonline.com](http://www.apsorderonline.com).

Return shipping address: American Power Sports 12300 Kinsman Rd, PO Box 299, Newbury, OH 44065

**Please Note:** If returning an item via US Mail please make sure the PO Box is included on the shipping address.

If you have any questions regarding a return contact our **Customer Service Department at (440) 564-8100**.  
**IMPORTANT:** All items must be returned complete as shipped. A partial return will delay processing of your return.

**SHIPPING CHARGES** All shipping charges are the customer's responsibility.

**COD CHARGES** All orders being sent COD are subject to an additional COD fee.

**REFUSED SHIPMENTS** A \$20.00 Service Charge plus shipping charges will be added to all accounts when a shipment is refused. **All refused shipment charges must be paid in full before any future orders can be shipped.**

**SALES TAX** Sales tax will be added to all orders shipped within Ohio.

**PAYMENT TERMS** All orders will be shipped certified check or money order, or you may charge to your **VISA, MasterCard, Discover or American Express**. Because we do not have the expense of collecting bad checks or overdue accounts, we are able to keep our prices as low as possible.

**VISA, MASTERCARD, DISCOVER or AMERICAN EXPRESS ORDERS** Orders being charged to a credit card, must be placed by the card holder and can only be shipped to the card holder's Billing Address or place of employment. Credit card orders cannot be shipped to any other person. Please have your card number and expiration date ready when placing an order.

**PRICES, POLICIES & TERMS** All prices, policies and terms are subject to change without notice.

**PRICING POLICY** Our policy is to provide quality products at low Racer Net prices. The printed prices were the current prices at the time of printing and we will make every effort to hold these prices. We will only increase prices when our suppliers increase prices to us.

**WARRANTIES AND GUARANTEES** American Power Sports does not guarantee the items sold by us or warranty the merchantability and fitness of purpose. Manufacturers supply their own warranties and guarantees and most of them do not permit us to make any adjustment, replace any part or accept for return or exchange any defective or unsatisfactory item. **Please follow the warranty or guarantee instructions provided by the manufacturer.** Any damages arising from the design or manufacturing of any item is the sole responsibility of the manufacturer.

**DISCLAIMER** Because of the wide variety of conditions under which the products contained in this catalog may be used or misused, the manufacturers and distributors DISCLAIM THE IMPLIED WARRANTY OF MERCHANTABILITY AND ANY AND ALL EXPRESS OR IMPLIED WARRANTIES. The purchaser and user accept full responsibility for the safe and proper use of these products and for damage to persons or property. The manufacturers and distributors will not be responsible for any damage to persons or property regardless of legal theory.

**BRAND NAMES** Brand names of motorized vehicles are used as reference only. Our intention is that our products can be used on our customer's vehicles. No products in our catalog are made as replacement parts by or with the permission of the original manufacturer.

**WARNING:** The products contained in this catalog are for off-road, non aircraft use only and are sold on "**AS IS BASIS**". There are no warranties express or implied. The user shall determine the suitability of these products and assume all risks and responsibility in connection with their use. Improper installation or usage of items contained in this catalog may result in serious injury or death.

**NEW PRODUCTS** If you do not see an item in the catalog, please ask about it. American Power Sports inventory is constantly updated and we may already have the item in stock or on order. Our computerized inventory system allows us to expand our inventory to meet all of your karting needs.

**WILL CALL SERVICE:** You may request to pick your order up at our facility instead of having it shipped. Hours vary so please call 440-564-8100 for more information. Ohio sales tax will be charged on all will call orders.

# INDEX

**ORDERS ONLY**  
**1-800-262-0555**  
**ALL QUESTIONS**  
**440-564-8100**

<b>A</b>		<b>F</b>		<b>R</b>	
AIR BOXES	137	FAIRINGS	32-33	RACERS TAPE	145
AIR FILTER ADAPTERS	108, 135-136,	FENDERS	161	RACING LAWN MOWERS	152-154
163		FILTER SOCKS	86, 134-137	RESTRICTOR PLATES	87, 93, 109
AIR FILTER OIL	134-135	FITTINGS	132	RIB PROTECTORS	16
AIR FILTERS	86, 109, 134-137	FLAGS	30	ROCKER ARMS	107
ARM RESTRAINTS	14	FLYWHEEL KEYS	86, 104	RODS	83, 95, 106, 154
AXLE COMPONENTS	2, 19, 36-37, 162	FLYWHEEL SCREENS	83, 104		
AXLES	19, 23, 26, 37, 162	FLYWHEELS	106		
		FUEL FILTERS	19, 126		
<b>B</b>		FUEL FITTINGS	127, 131	<b>S</b>	
BAND BRAKES	171	FUEL JUG	127	SAFETY WIRE & TOOLS	143
BEAD BREAKERS	64	FUEL LINE	126-127	SCALES	139
BEARING SHIELDS	36	FUEL PUMPS	131	SEAT BELTS	14
BEARINGS	19, 23, 25-26, 36, 58-59,	FUEL TANKS	128-129	SEAT PADDING	34
	70, 96, 164-165	FUNNELS	127	SEAT STRUTS	34
				SEATS	35, 161, 163
BELTS	159	<b>G</b>		SHOCK ABSORBERS	163
BODYWORK	31	GASKETS	3, 83, 88, 94, 100-101, 106	SHOES	10
BOOKS	173	GAUGES	65, 148-151	SIDE PANELS & PODS	31-33
BRACKETS	28	GIFT CARDS	54	SILENCERS <sup>98</sup>	106, 137
BRAKE COMPONENTS	23	GLOVES	5, 14	SPARK PLUG CAPS	138
BRAKE DISCS	2, 18, 47, 49-50, 171	GRAPHICS	4, 30	SPARK PLUGS	87, 138
		GRAPHICS GUARDS	33	SPINDLES	22-24, 26, 172
				SPROCKET HUBS	2, 18, 26, 38, 40, 167
BRAKE DRUMS	164, 170-171	<b>H</b>		SPROCKET ORGANIZERS	42
BRAKE LINES	51-52	HARDWARE	2, 18, 22-27, 28-29,	SPROCKET PROTECTORS	39, 42
BRAKE PADS	44		32-34, 54, 56, 58, 67-68,	SPROCKETS	38-39, 41, 44, 153,
BRAKES	45-52	HEADER WRAP	88, 97, 100, 111, 118-119, 127		155, 164, 168-169
BRIGGS ENGINES & PARTS	78-104	HEADERS	100		
BUMPERS	20, 22, 24, 27, 32	HELMET ACCESSORIES	87-88, 98-99, 106, 152	STAGGER TAPE	65
		HELMET BAGS	7-9	STARTER NUTS	133
		HELMET SHIELDS	6, 9	STARTERS	133
BUSHINGS	161	HELMET SHIELDS	7-9	STEERING COMPONENTS	67-68, 155
		HELMET SUPPORTS	6, 14	STEERING WHEELS	2, 69, 148
		HELMETS	7-8	STOP WATCHES	147
<b>C</b>		HONES	142		
CABLE TIES	130			<b>T</b>	
CABLES	18, 132	<b>J</b>		TACH & TEMP GAUGES	148-151
CAMS	82, 92-93, 109	JACKETS	10-11, 13, 15	TEAR-OFFS	7-9
CARB ADJUSTOR	130	JACKSHAFT KITS	160	TECH MANUAL	173
CARBURETOR PARTS	102-103, 108	JR DRAGSTER	152	THIRD BEARING SUPPORTS	76-77
CARBURETORS	84, 97, 101, 108			THROTTLE LINKAGE	83-84, 86,
		<b>K</b>			97, 101, 108, 130-131,
CASSETTES	19, 23, 25-26, 36	KART COVERS	30		155, 160
		KART STANDS	20	TIE RODS & ENDS	19, 22, 24, 26,
CATCH TANKS	72	KEYSTOCK	19, 37, 70		67-68, 70, 172
CHAIN	43, 153, 155, 162, 163	KILL BUTTON	161	TIRE COVERS	145
				TIRE GAUGES	65
CHAIN COVERS	71	<b>L</b>		TIRE GROOVER	64
CHAIN GUIDES	2, 42	LIFTERS	82, 93	TIRE TOOLS	64
CHAIN LUBE	42-43, 156-157	LOCK COLLARS	70, 162	TIRE TREATMENTS	63
CHAIN TOOLS	39, 43			TIRES	60-62, 163-164, 166
CHASSIS COMPONENTS	22-27	<b>M</b>		TOOLS	17, 20-21, 39, 64, 82-83,
CHASSIS TOOLS	17, 20-21	MANIFOLDS	84, 101		85-86, 92, 96-97, 102-103,
CHECK VALVE	126	MIN-CUP	153-154		109, 112, 122, 125, 139-144
CHEST PROTECTORS	16	MINI-BIKE COMPONENTS	160-161	TORQUE CONVERTORS	159
CLAMPS	33, 126, 146	MINI-BIKE KITS	160	TRI-FLOW	156
CLEANERS	11, 30, 63, 134	MOUNTS	73-77, 125, 137, 148	TUBES	163-164, 166
CLONE ENGINE PARTS	3, 105-109			TY WHEELS	160
CLONE ENGINES	105	MUFFLERS	98, 106, 124	TY RAPS	130
CLUTCH PARTS	3, 110-123				
CLUTCHES	110-123, 159	<b>N</b>		<b>V</b>	
COILS	104	NOMEX RACEWEAR	15	VALVE SPRINGS	82, 84, 93, 107, 109, 152
CONICAL WASHERS	29, 34	NOSES	31-32	VALVES	84, 107
CONTROL COMPONENTS	66	NUMBER PLATES	146		
COTTER PINS	20	NUMBERS	146	<b>W</b>	
				WEIGHT TANKS	72
<b>D</b>		<b>O</b>		WHEEL BALANCERS	54, 64
DECALS	4, 30	OILS	156-158	WHEEL HUBS	2, 18, 53, 58-59, 152-153, 167
DISC BRAKES	45-52, 153, 171			WHEEL HUBS	18
		<b>P</b>		WHEEL WEIGHTS	65
DRIVING SUITS	1, 13, 15	PANTS	12, 15	WHEELS	53-57, 152-153, 164-166
DRUM BRAKES	170	PEDAL EXTENTIONS	21		
DVD'S	3	PEDAL GRIPS	21, 66		
		PEDALS	21, 25, 66		
<b>E</b>		POLICIES & TERMS	174-175		
ENGINE MOUNTS	73-77	PRE FILTERS	86, 134-137		
ENGINE PARTS	78-109	PULLEY CLUTCHES	159		
ENGINES	78, 105	PULLEYS	19		
EXHAUST ACCESSORIES	125	PUSH RODS	84-85, 107, 152		
EXHAUSTS	87-88, 98-99, 124				
		<b>Q</b>			
		QUARTER MIDGET	155		

American Power Sports also stocks many items that are not contained in this catalog.

The following product lines are available and may be ordered through our on-line store, [www.apsorderonline.com](http://www.apsorderonline.com) or by calling 440-564-8100: **Comer Engines/Parts, Odenthal Engine Mounts, Pfeifer Belt Drives, Rotax Engines/Parts, Sonik Engines/Parts, Tomar Clutches/Parts & Yamaha Engines/Parts.**

**\*\*NOTE: PLEASE VISIT [www.apsorderonline.com](http://www.apsorderonline.com) or CALL 440-564-8100 FOR INFORMATION**

